

Commodore
16

**Owner's
Guide**

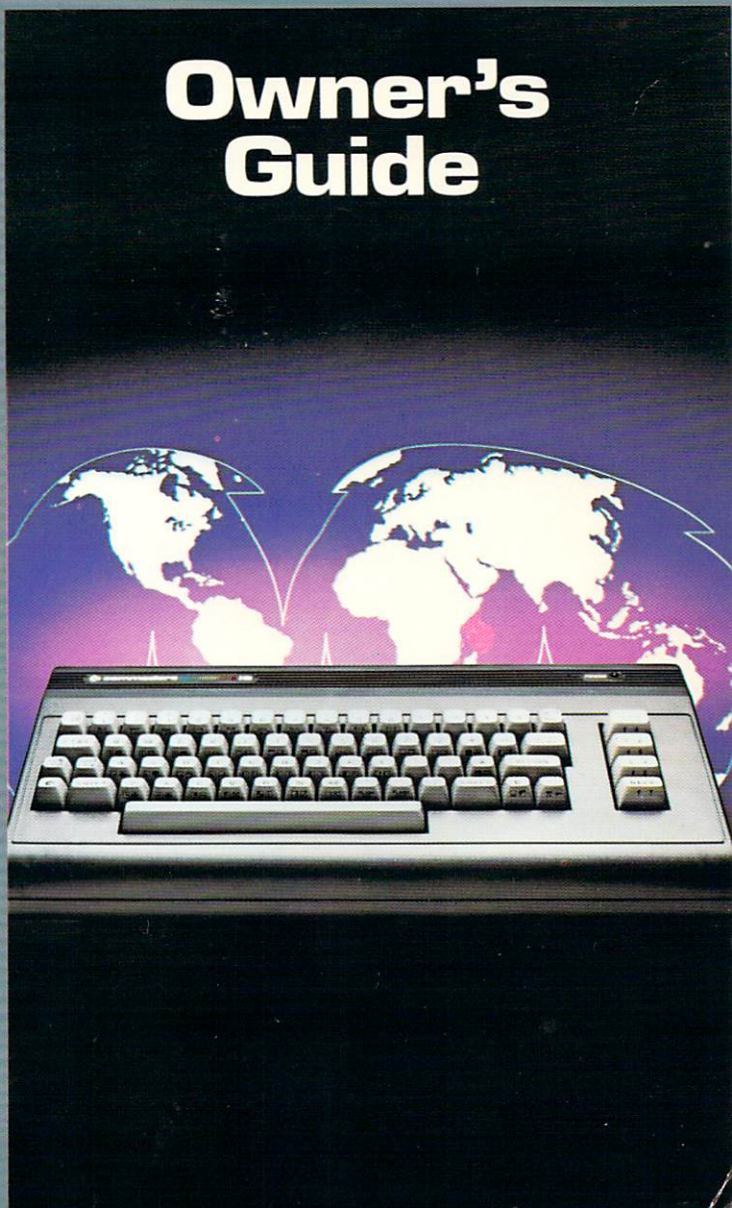

OWNER'S GUIDE STATEMENT

"This equipment generates and uses radio frequency energy. If it is not properly installed and used in strict accordance with the manufacturer's instructions, this equipment may interfere with radio and television reception. This machine has been tested and found to comply with the limits for a Class B computing device in accordance with the specifications in Subpart J of Part 15 of the FCC Rules, which are designed to provide reasonable protection against such interference in a residential installation. If you suspect interference, you can test this equipment by turning it off and on. If you determine that there is interference, with radio or television reception, try one or more of the following measures to correct it:

- reorient the receiving antenna
- move the computer away from the receiver
- change the relative positions of the computer equipment and the receiver
- plug the computer into a different outlet so that the computer and the receiver are on different branch circuits

If necessary, consult your Commodore dealer or an experienced radio/television technician for additional suggestions. You may also wish to consult the following booklet, which was prepared by the Federal Communications Commission:

"How to Identify and Resolve Radio-TV Interference Problems". This booklet is available from the U.S. Government Printing Office, Washington, D.C. 20402, Stock No. 004-000-00345-4."

You should use only the cables, accessories, and peripherals recommended by Commodore for your Commodore 16. All cables, including the cables for the television hookup, serial port, video port, Datassette, and joysticks, are specially shielded, in accordance with the regulations of the Federal Communications Commission. Failure to use the appropriate accessories and cables will invalidate the FCC grant of Certification, and may cause harmful radio interference.

COMMODORE 16 OWNER'S GUIDE

*A FRIENDLY INTRODUCTION TO YOUR
COMMODORE 16*

**Published by
Commodore Business Machines, Inc.**

THE INFORMATION IN THIS MANUAL HAS BEEN REVIEWED AND IS BELIEVED TO BE ENTIRELY RELIABLE. NO RESPONSIBILITY, HOWEVER, IS ASSUMED FOR INACCURACIES. THE MATERIAL IN THIS MANUAL IS FOR INFORMATION PURPOSES ONLY, AND IS SUBJECT TO CHANGE WITHOUT NOTICE.

Copyright © 1984 by Commodore Electronics Limited
All rights reserved.

THIS GUIDE CONTAINS COPYRIGHTED AND PROPRIETARY INFORMATION. NO PART OF THIS PUBLICATION MAY BE REPRODUCED, STORED IN A RETRIEVAL SYSTEM, OR TRANSMITTED IN ANY FORM OR BY ANY MEANS, ELECTRONIC, MECHANICAL, PHOTOCOPYING, RECORDING OR OTHERWISE, WITHOUT THE PRIOR WRITTEN PERMISSION OF COMMODORE ELECTRONICS LIMITED.

Commodore BASIC v. 3.5

Copyright © 1984 by Commodore Electronics Limited, all rights reserved.
Copyright © 1977 by Microsoft, all rights reserved.

TABLE OF CONTENTS

INTRODUCTION	i
SECTION 1 Setting Up	1
SECTION 2 Looking at the Keyboard	11
SECTION 3 Using Software	25
SECTION 4 Learning the BASICS	36
Numbers and Calculations	37
Programming	42
Sound and Music	45
Graphics and Color	48
SECTION 5 ETC.	
Peripherals	53
Book List	56

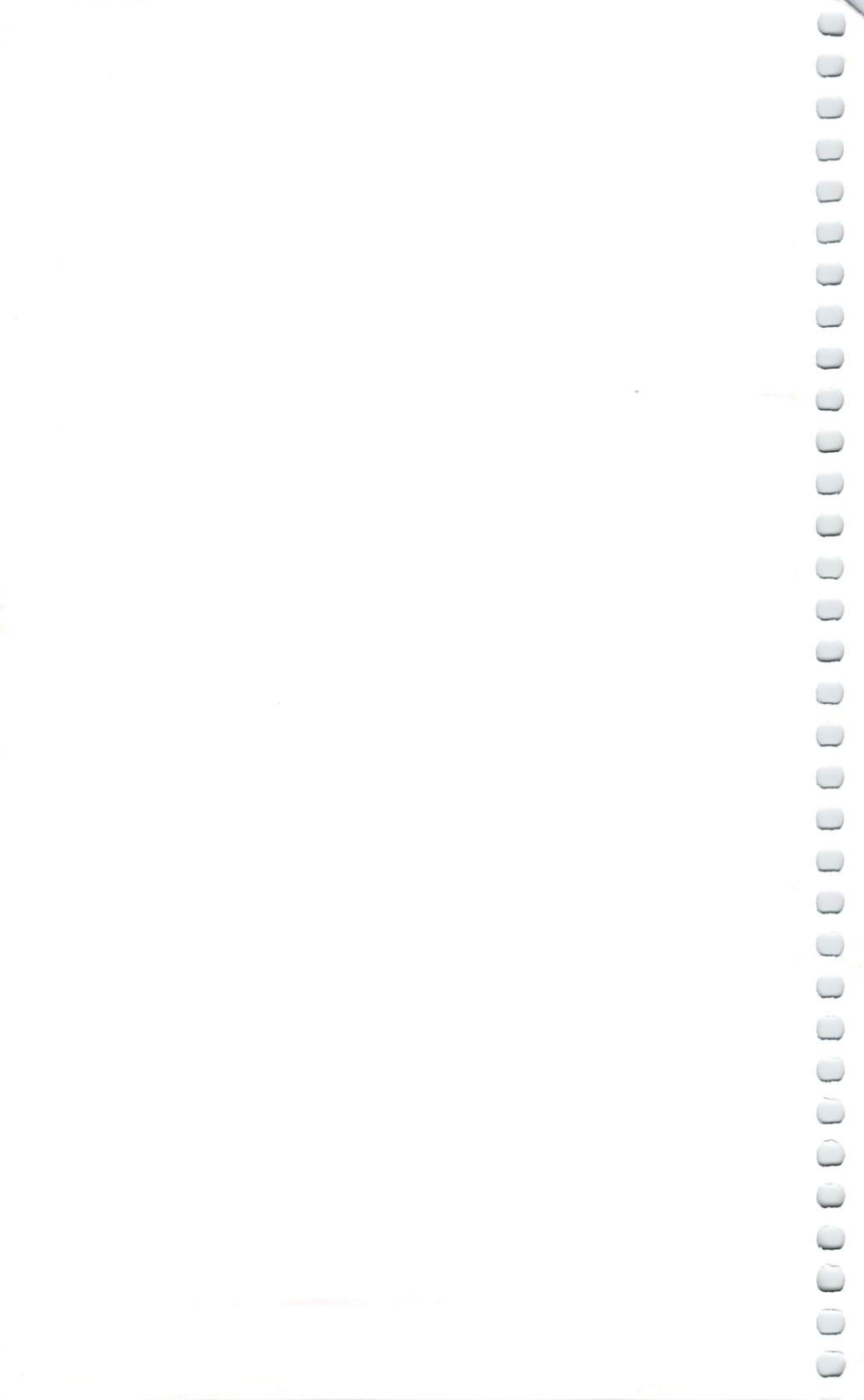

Introduction

The Commodore 16 personal computer is your passport to the Information Age. With the Commodore 16, you have the ability to quickly process many kinds of information — personal, educational, scientific, financial. And with the Commodore 16 you can present this information in almost any form — in words, numbers, pictures or sound, or in any combination of these forms.

You can use your Commodore 16 in a number of ways. You can select from many easy-to-use software products that are available on cartridge, tape and disk. You can also create and store your own programs. In either case, the full processing power of the Commodore 16 is at your disposal.

Using This Guide

To start using your Commodore 16, follow these steps:

- Unpack all the equipment and set it up according to the directions given in Section 1, Setting Up Your Computer.
- Plug in the Commodore 16 Tutor Cartridge which will give you complete “hands-on” training on all keyboard functions. (Note: Information related to what this cartridge covers is presented in Section 2 of this Guide, Looking At The Keyboard. You can refer to the printed version of the instructions when you are away from the keyboard, or when you have another cartridge plugged in.)

- Read Section 3, Using Software. This section tells you how to use software that is packaged in any of the three basic packaging forms — cartridge, cassette tape, and disk — as well as the units needed to use cassettes and disks. When you have completed this section, you will be ready to use the Commodore software packages available at your local dealer. You'll be able to use software even without reading the rest of the Guide.
- If you are interested in programming the Commodore 16 yourself, you will want to read Section 4, Learning the BASICs. This section describes the Commodore 16's computational capabilities and introduces the advanced BASIC programming language that is built into your computer. The sophisticated sound, music, color, and graphics capabilities of the Commodore 16 are also introduced in this section. For detailed descriptions of all these topics, see the Commodore 16 Intermediate User's Manual.
- Consult the appendices for additional helpful information, including information on equipment that can expand the Commodore 16's capabilities even more, and a list of books you may find helpful.

You'll soon see that you can begin to use your Commodore 16 as soon as you have set up and connected all the equipment. How far and how fast you go from here is up to you. You are in control.

1

SETTING UP YOUR COMPUTER

- **Unpacking your Commodore 16**
- **Getting to know the switches and sockets**
- **Setting up your Commodore 16**
- **Troubleshooting chart**

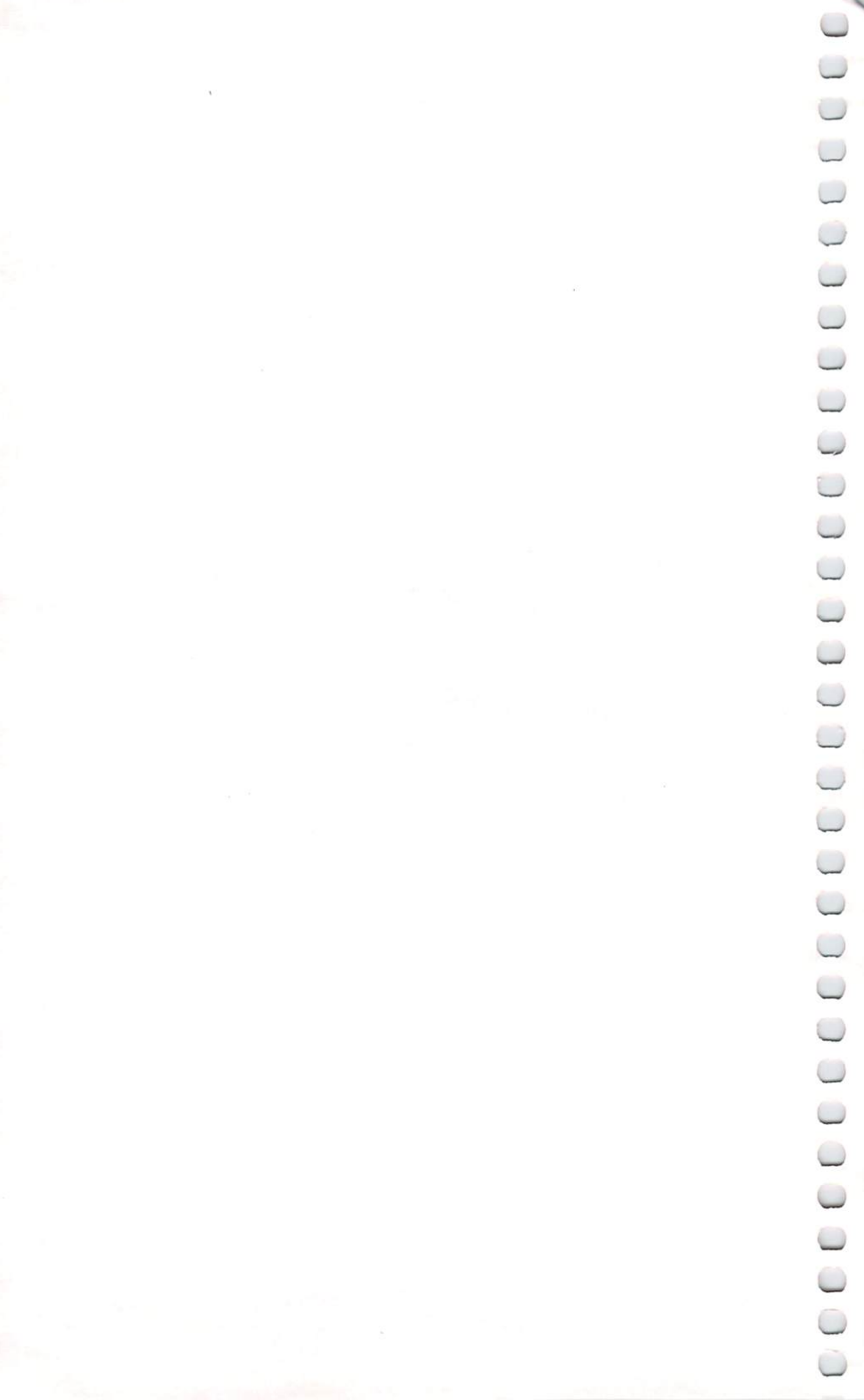

1

SETTING UP YOUR COMPUTER

Unpacking Your Commodore 16

When you open the box, here's what you should have:

1. Your Commodore 16



2. The supply power
3. The TV switchbox
4. The RF (Radio Frequency) cable
5. The Owner's Guide
6. Tutor cartridge
7. Warranty card
8. Commodore Magazines subscription card

If you don't find all these items in the box, check with your dealer immediately for replacements.

SETTING UP YOUR COMPUTER

Getting To Know The Switches And Sockets

Take the time to review the next few pages while making sure where each switch or socket is located on your computer. This will save time and confusion later on.

The Right Side Of Your Commodore 16

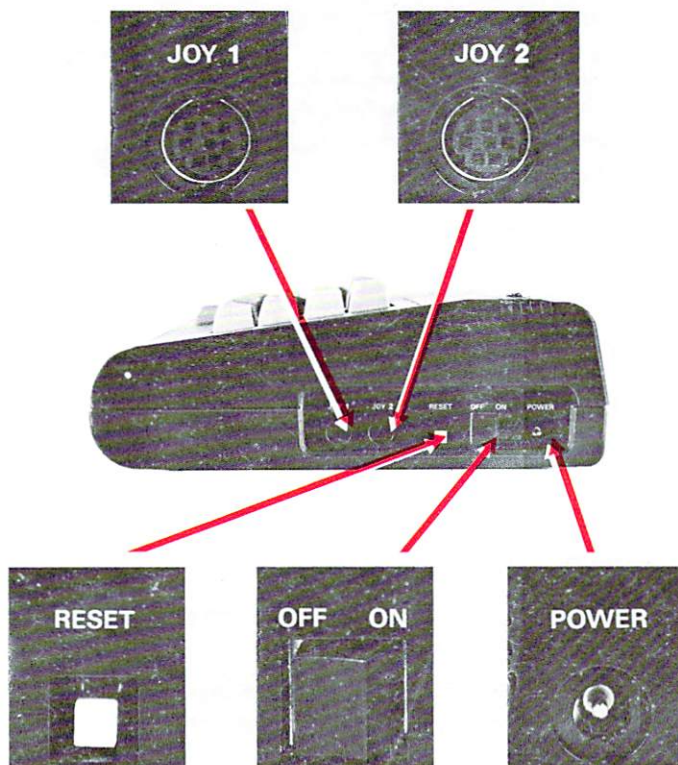

1

SETTING UP YOUR COMPUTER

The On/Off Switch

- There is a red power light located above the keyboard on the right. This lights to show you that the power is ON.
- Make sure your Commodore 16 is turned OFF when you install or remove cartridges or any peripheral device, such as a printer or disk drive.

The Joystick Sockets

- The joystick controllers plug in here.
- Your Commodore 16 uses specially designed joysticks for games and other uses, available from your Commodore dealer.

The Reset Button

- Press the reset button when you want to "start over", to get a cleared screen and memory as if you just turned your computer off then on again.

The Power Socket

- The round end of the cord from your power supply plugs in here.

SETTING UP YOUR COMPUTER

The Back Of Your Computer

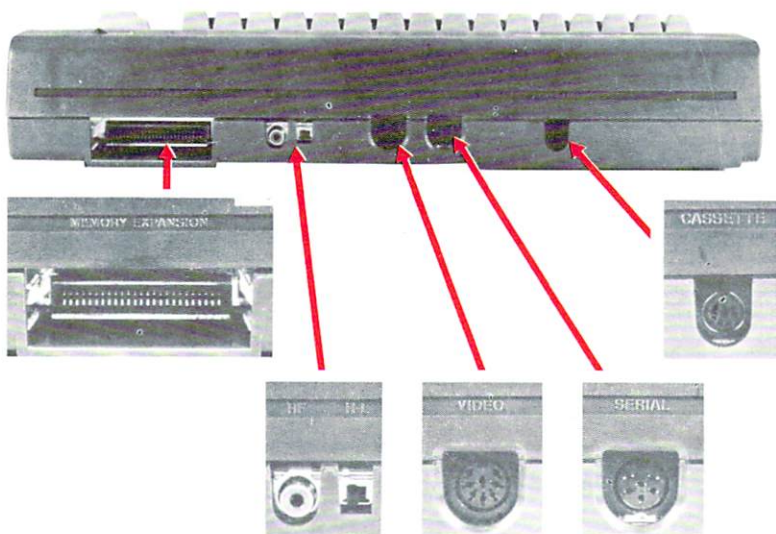

The Memory Expansion (Cartridge) Port

- Commodore 16 software cartridges plug in here. (Port is the term for the rectangular opening.)

The RF Jack

- This is where you plug in one end of the RF cable (the thin black cable) to hook up your computer to a TV set.

The Video Socket

- Here's where you plug in the round end of the cable if you want to connect a color monitor (instead of a TV set) to your Commodore 16.

SETTING UP YOUR COMPUTER

YOU CAN USE *EITHER* THE RF JACK OR VIDEO SOCKET—YOU WON'T NEED BOTH!

The High/Low Switch

- Use this switch to set your Commodore 16's TV channel output:

You can use either channel 3 or 4 on your TV to display the video picture from your computer. Set this switch to L to use your computer on channel 3, or to H for channel 4. If you have a TV station on channel 3 in your area, select channel 4, and vice versa. Experiment to see which setting gives you the best picture. If you have a monitor, you won't need to worry about this switch.

The Serial Socket

- You can plug a disk drive or a printer into this socket.

To use both, first plug the disk drive into this opening, then plug the printer cable into the back of the disk drive.

The Cassette Port

- The Commodore 1531 Datassette™ tape recorder for cassette tape software plugs in here.
- The Datassette is used to load or store programs on cassette tape, and is specially designed for your Commodore 16.

1

SETTING UP YOUR COMPUTER

Setting Up Your Commodore 16

Connecting your Commodore 16 is as easy as 1-2-3:

- 1** Hook up the silver SWITCHBOX to the back of your TV.
- 2** Plug in the POWER SUPPLY on the right side of your computer and into a wall plug.
- 3** Connect the RF cable (the thin black one) from the TV SWITCHBOX to the RF SOCKET on the back of your computer.

REMINDER: The power on everything (computer, TV, etc.) should be turned OFF until you are completely set up and ready to go.

1

Installing The TV Switchbox

You'll need a small flat-headed screwdriver to connect the switchbox. (A dime is even too thick!)

- Disconnect the VHF antenna leads from the back of the TV.
- Connect the leads on the switch box to the VHF screws.

SETTING UP YOUR COMPUTER

- Connect the antenna leads to the screws on the bottom of the switchbox (to the 75 or 300 ohm screws, depending on your antenna).
- Peel off the paper strip that's covering the adhesive square on the back of the switchbox and stick the switchbox onto the back of your TV.

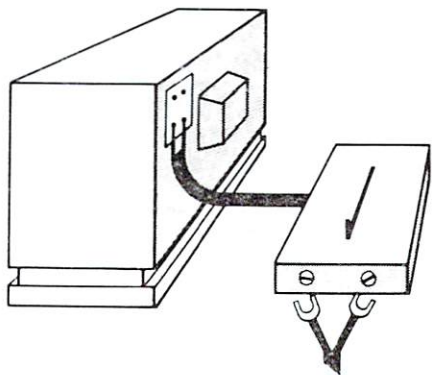

2 Connecting The Power Supply

- Plug the round end of the POWER SUPPLY into the POWER JACK on the right side of your computer.
- Plug the other end into an electrical wall socket.

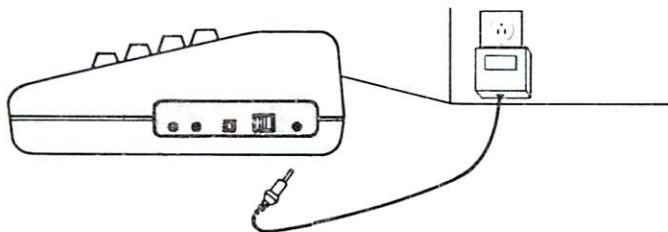

SETTING UP YOUR COMPUTER

3 Plugging In The RF Cable

- Plug either end (it doesn't matter which) of the RF cable into the top of the SWITCHBOX in the opening labelled "COMPUTER".
- Plug the other end of the cable into the RF jack on the back of your computer.

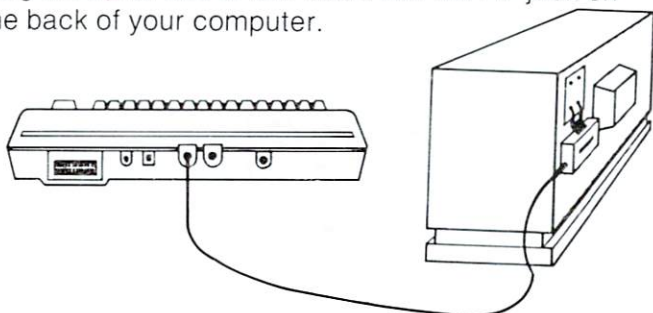

You need to connect everything to your TV only once. When you want to use your computer, move the switch on the SWITCHBOX to the COMPUTER position. When you want to watch TV, move the switch to TV. The switchbox will not interfere with your TV reception.

Connecting Your Commodore 16 To A Monitor

If you're connecting your computer to a monitor instead of a TV, follow the instructions in the monitor manual. Hooking up a monitor like the Commodore 1702 Color Monitor is simple. You need to connect only one cable which goes directly from your monitor to the VIDEO socket on the back of your computer. You do NOT need to use the switchbox and the RF cable.

SETTING UP YOUR COMPUTER

Finally . . .

Now it's time to turn on your computer. Turn on the POWER switch on the right side of your computer.

If all went well, the red POWER light will go on, and here's how your screen will look:

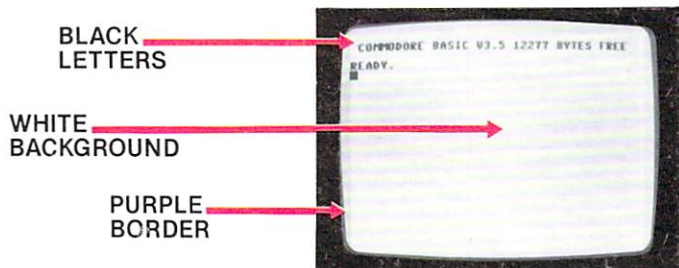

The flashing block under the word READY is called the cursor. The cursor tells you that the computer is ready. If something went wrong, the Troubleshooting Chart should come in handy.

IMPORTANT: Some TV sets cannot display the entire Commodore 16 screen. Instead, their picture cuts off the far left and far right column of the screen. We recommend using a different TV set or a monitor such as the Commodore 1702, 1802 or 1803 color monitor.

If this isn't possible, you can deal with the problem by pressing the ESC key, followed by the R key. This reduces the computer screen display size to 38 columns, so that the entire picture fits on the screen. You must repeat this each time you power up or reset your computer.

SETTING UP YOUR COMPUTER

TROUBLESHOOTING CHART

Symptom	Cause	Remedy
Indicator light not 'ON'	Computer not turned ON	Make sure power switch is in ON position
	Power cable not plugged in	Check power socket for loose or disconnected power cable
	Power supply not plugged in Bad fuse in computer	Check connection with wall outlet Take system to authorized dealer for replacement of fuse
No picture	TV on wrong channel Incorrect hookup	Check other channel for picture (3 or 4) Computer hooks up to VHF antenna terminals
	RF cable not plugged in	Check TV cable connection
	Computer set for wrong channel	Set computer for same channel as TV
Random pattern on TV with cartridge in place	Cartridge not properly inserted	Reinsert cartridge after turning OFF power
Picture without color	Poorly tuned TV	Retune TV
	TV not connected properly Color set too low on TV or computer	Check connections Adjust color setting
Picture OK, but no sound	TV volume too low	Adjust volume of TV
	Poorly tuned TV	Retune TV

2

LOOKING AT THE KEYBOARD

- Introduction
- Using your computer like a typewriter
- Special keys

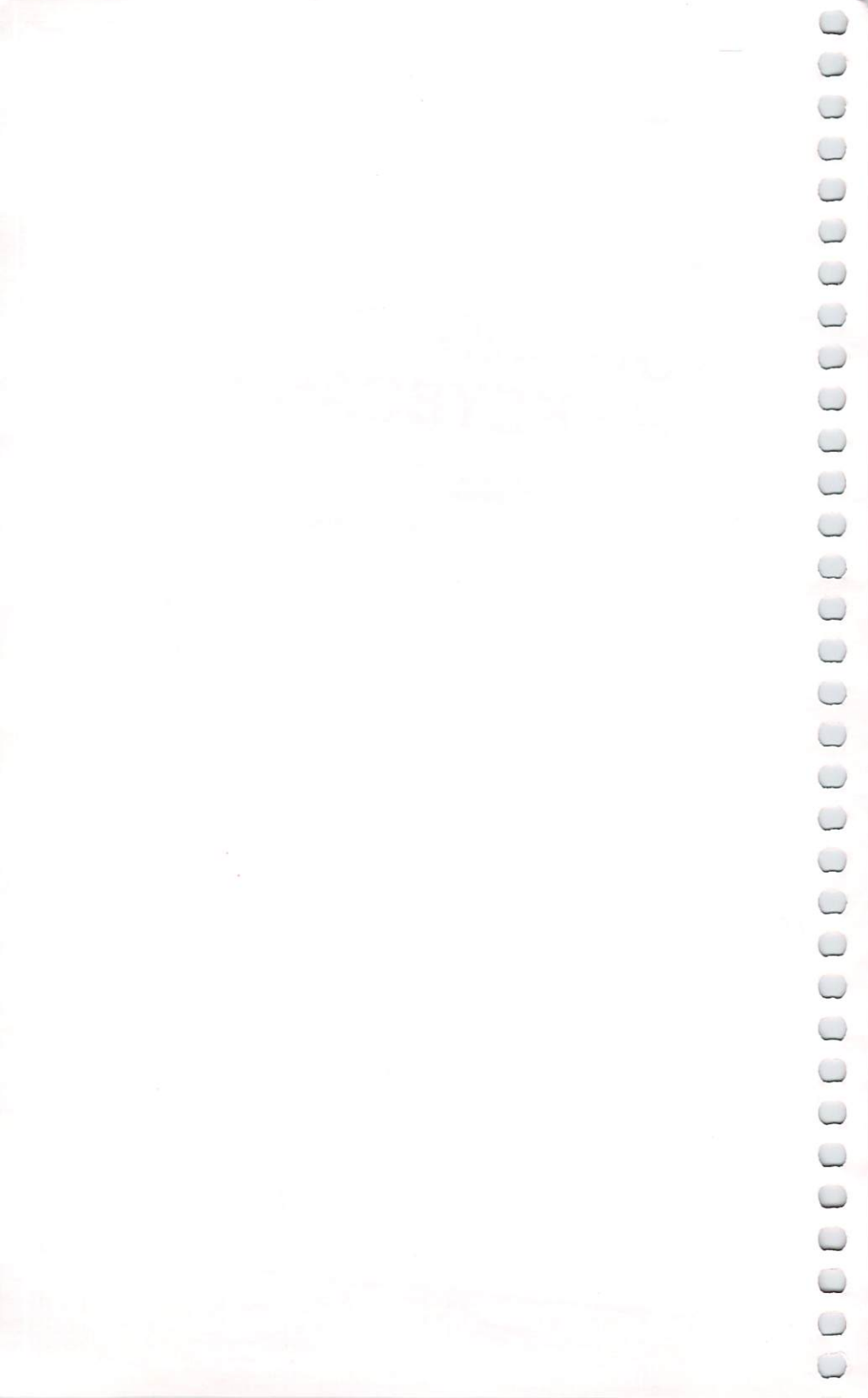



2

LOOKING AT THE KEYBOARD



Introduction



Most of the keys on your Commodore 16 keyboard are identical to the keys on a typewriter, but each key can do more than a typewriter key. In this section you'll learn how to use special keys like the  key and the four separate cursor keys. This section will show you the extra features of every key, including how to use the graphic symbols pictured on the fronts of many of the keys.

When you first type letters on your computer, they appear as capitals on the screen. The letters and numbers appear on the screen exactly as they appear on the face of the key when you press the key by itself. Also, several other keys (+, -, =, @, *, and the English pound sign) may be typed alone. Some punctuation marks need to be typed with the  key.

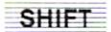
Using Your Computer Like A Typewriter

- If you want to do "regular" typing, you can type in CAPITAL and lowercase letters (as you would on a typewriter) by pressing the  key and the  key at the same time to change into typing (UPPERCASE/lowercase) mode.

2

LOOKING AT THE KEYBOARD

- After you do this, all letter keys typed alone are in lower-case. When you press the **SHIFT** key along with a letter, you get a capital letter. Try typing with and without the **SHIFT** key. Numbers and punctuation keys work the same as they would in non-typing mode.
- To get out of typing mode, just press the two keys (**SHIFT** and ) together again. The lower-case letters on your screen become capitalized and the capitals become graphic symbols.

KEY + KEY = EFFECT

SHIFT +  = ENTER (OR EXIT)
TYPING MODE

A = a

A + **SHIFT** = A

A +  = 

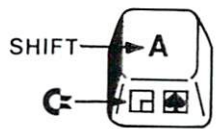

Special Keys

- The Commodore 16 keyboard contains special symbols not found on many typewriters, or even on most computers. These include:

The English pound sign (£) — Press by itself.



Pi (π) — Press with the  key.



2

LOOKING AT THE KEYBOARD

Greater and less than signs (< >) — Press



or



along with **SHIFT**.

Brackets ([]) — Press



or



with **SHIFT**.

Arrows (← ↑) — Press



or



with **SHIFT**.

- Many of the keys on your Commodore 16 keyboard behave differently than normal typewriter keys.
- These keys act to enable other keys to do things they wouldn't ordinarily do, or perform functions related to programming.

RETURN

- Enters information and instructions into your computer.

2

LOOKING AT THE KEYBOARD

SHIFT

- Used to modify what other keys print on the screen.
- The **SHIFT** key allows you to type capital letters, graphic symbols, punctuation marks, and get into typing mode when pressed with another key.

SHIFT LOCK

- The **SHIFT LOCK** key is the same as the **SHIFT** key, except that it is locked into place, so you don't have to hold it down.
- To release the lock, just press **SHIFT LOCK** again so that everything you type is back to normal (unshifted).

RUN/STOP

- Press this key to STOP what your Commodore 16 is doing.
- When your computer is running a program, pressing this key gets you back in control of the keyboard.

When you hold down the **SHIFT** and **RUN/STOP** keys simultaneously, the Commodore 16 loads and runs the first program on a disk in the disk drive.

2

LOOKING AT THE KEYBOARD

The Cursor Keys



- The cursor, the flashing block that marks where you are on the computer screen, can be moved quickly and easily around the screen by using the CURSOR KEYS.
- There are four separate cursor keys, each with an arrow pointing in the direction the key moves the cursor: up, down, left or right.
- You can use the cursor keys to move the cursor over anything on the screen without affecting those characters.

Like all keys on the Commodore 16 keyboard, each cursor key can automatically repeat. This means that if you hold down the key continuously, the cursor keeps moving in the direction of the key you press until you release it. Keys that print on the screen will fill each space with their characters while you hold them down like this.

2

LOOKING AT THE KEYBOARD

INST/DEL

- You can INSERT and DELETE letters and numbers from the line you are typing with this key.
- When you press this key by itself, the typed character immediately to the left of the cursor disappears, and the cursor moves to where the missing character was.
- To open up space to insert letters and numbers, type this key along with SHIFT. When you insert space in the middle of a line, the line to the right of the cursor moves further to the right.

The INST/DEL key saves a lot of time when you want to edit or change what you've typed.

KEY + = EFFECT

INST/DEL = DELETE (ERASE TYPED CHARACTERS)  SHIFT

INST/DEL + SHIFT = INSERT (ADD SPACES)

CLEAR/HOME

- This is a "double" key: you can use it for CLEAR and HOME functions.
- When you press this key alone, the cursor immediately moves to the top left corner of the screen (which is known as the HOME position). The rest of your screen stays the same.

2

LOOKING AT THE KEYBOARD

- If you hold down the **SHIFT** key and press **CLEAR/HOME**, not only does the cursor move to HOME, but everything on the screen is erased (or cleared). All that remains on the screen is the blinking cursor at the top left corner of the screen.

KEY + = EFFECT

CLEAR/HOME = HOME POSITION

CLEAR/HOME + **SHIFT** = CLEAR SCREEN











CTRL (Control)



- The **CTRL** key is like the **SHIFT** key in that it always works with another key.
- **CTRL** has three functions:
 1. As the COLOR KEYS section explains, pressing **CTRL** and a color key lets you change the color of what you print on the screen.
 2. You can pause a program that is PRINTing or LISTing on the screen by pressing **CTRL** and the S key.
(To restart the program, press any key.)
 3. **CTRL** is also used with **REVERSE ON/OFF** and **FLASH ON/OFF**. These are explained later in this section.
- In addition, some software programs you can buy make use of the **CTRL** key for their own special functions.

2

LOOKING AT THE KEYBOARD

(Commodore Key)

- The Commodore key is very similar to , and can be used to perform four functions:
 1. When used with the  key, the  key lets you get into typing mode, where you can use both upper and lowercase letters.
 2. The  key always acts as a shift to let you type the graphic symbol pictured on the LEFT front of each key. Just hold down  and press the graphic key you want.
 3. The  key is used like the  key to change the color of what you type on the screen when pressed with a COLOR KEY.
 4. When you want to slow down a scrolling display (a program that appears line-by-line on the screen but might be going by too fast to follow), hold down the  key. The display scrolling speed slows down considerably. When you release the key, it goes back to normal speed.

NOTE: When pressing a modifying key (,  or ) along with another key, make sure you press them at the same time or press the modifying key a split second earlier.

2

LOOKING AT THE KEYBOARD

RVS ON **RVS OFF** (Reverse On/Off)

- Press **RVS ON** and **CTRL** at the same time to print the reverse image of letters and numbers on your screen. In other words, if your cursor is black and the screen background is yellow, what you type appears in yellow letters on a black background.

REVERSED LINE

- To turn off reverse printing, press the **RVS OFF** and **CTRL** key. You can also turn off reverse by pressing the **RETURN** key, or the **ESC** key and 0. This returns you to typing in normal print.

KEY + = EFFECT

CTRL + **RVS ON** = REVERSE PRINTING ON



CTRL + **RVS OFF** = NORMAL PRINTING







FLASH ON **FLASH OFF**



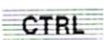
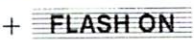

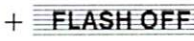
- You can make the characters on your screen flash on and off continuously, like the cursor flashes. Press **FLASH ON** and the **CTRL** key together to make whatever you type flash.
- Typing **FLASH OFF** and **CTRL**, or **RETURN**, or **ESC** and 0 makes your typing normal (non-flashing) again.

2

LOOKING AT THE KEYBOARD









KEY	+		= EFFECT	
	+		= CHARACTERS FLASH	
	+		= NORMAL DISPLAY	

Colors Keys

- The color keys are actually the number keys from 1 to 8, when you press one with either the  or the  key.
- These change the color on the screen of everything you type.
- On the front of each of the number keys from 1 to 8, there are abbreviations for two colors.
- Press  along with a number key to get the color listed on top.
- Press the  key with a number to get the color on the bottom.
- Make sure you press the two keys at the same time; if you press the number key first, you'll just type the number on the screen.

2

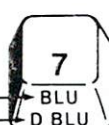
LOOKING AT THE KEYBOARD

KEY + CTRL = EFFECT	KEY + CTRL = EFFECT	
1 + CTRL = BLACK	1 + CTRL = ORANGE	
2 + CTRL = WHITE	2 + CTRL = BROWN	
3 + CTRL = RED	3 + CTRL = YELLOW GREEN	
4 + CTRL = CYAN	4 + CTRL = PINK	
5 + CTRL = PURPLE	5 + CTRL = BLUE GREEN	
6 + CTRL = GREEN	6 + CTRL = LIGHT BLUE	
7 + CTRL = BLUE	7 + CTRL = DARK BLUE	
8 + CTRL = YELLOW	8 + CTRL = LIGHT GREEN	

2

LOOKING AT THE KEYBOARD

Graphic Keys

- Each letter key (and a few other symbol keys) on your Commodore 16 has two boxes on the front, each with a different graphic symbol. There are more than 60 graphic symbols you can use.
- Type **SHIFT** and a key to print the symbol on the right. This set of symbols contains card suits, circles, lines and arcs.
- Type **⇧** and a key to print the symbol on the left. The left side graphics are ideal for creating charts, graphs, and business forms.

KEY + = EFFECT

A + **⇧** = **⌞** (GRAPHIC ON
LEFT SIDE OF KEY)

A + **SHIFT** = **♠** (GRAPHIC ON
RIGHT SIDE OF KEY)



You can create pictures, charts and designs by printing graphics side-by-side or on top of each other, like building blocks. You can make your graphics more interesting by using the color keys to "draw" in different colors. Try typing some of these graphic symbols; experiment a little.

2

LOOKING AT THE KEYBOARD

- When you're in typing mode, you can use only the graphic symbols on the left front of the keys (by pressing  and the appropriate key).

Function Keys

- The four larger keys on the right side of your keyboard, apart from the rest of the keys, are special function keys that let you save typing time by automatically printing or actually carrying out a frequently-used command (such as clearing the screen or RUNning a program) with the press of one key.
- Each function key can be considered to be two separate keys: one when pressed alone (f1, f2, f3 and HELP functions) and a second when pressed along with  (f4, f5, f6 and f7).
- The function keys are useful when you get into BASIC programming. More information on these keys is available in the Commodore 16 Intermediate User's Manual and the Series 264 Programmer's Reference Guide.

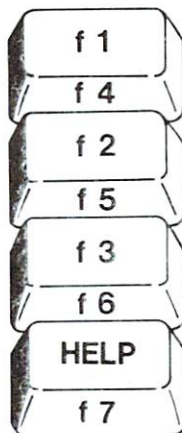

2

LOOKING AT THE KEYBOARD

The Help Key

- When you make a mistake in a program, your computer displays an error message to tell you what you did wrong.
- When you press the **HELP** key, the line causing a problem is automatically displayed, flashing on and off.



For example, if you get this message:

?SYNTAX ERROR IN LINE 10

When you press **HELP**, the computer shows the offending line flashing on and off, for example:

**10 PRONT "COMMODORE
COMPUTERS"**

You typed **PRONT** instead of **PRINT**, as you can see in the flashing line.

3

USING SOFTWARE

- Introduction
- Cartridges
- Cassettes
- Diskettes

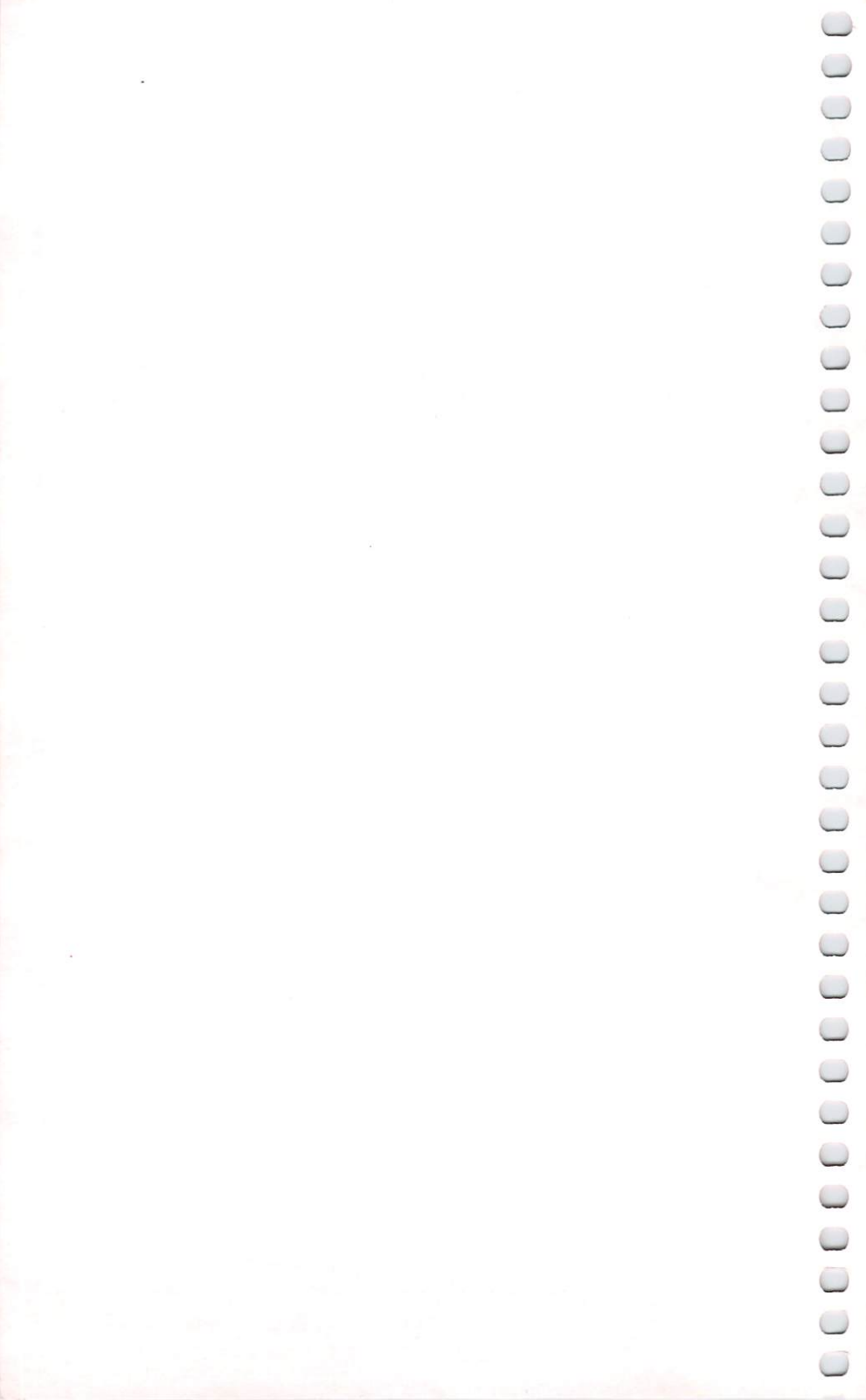

USING SOFTWARE

Introduction

Software expands the scope of your computer, giving you access to an entire library of personal, business, educational, scientific and entertainment programs. Software can be defined as the programs that can be entered and run on a computer. To use any software on your computer, you must LOAD the software program into the computer's memory. There are different LOADING instructions, depending on what kind of software it is. The hardware (in this case, your Commodore 16) can use software in many forms: plug-in cartridges, pre-recorded tapes and diskettes. The family of software available for your Commodore 16 is growing quickly. Your dealer can keep you up-to-date on new products and inform you about the features of software that's currently available.

Cartridges

- Commodore produces a full assortment of cartridges software for your Commodore 16. There is a variety of personal, education, and business programs, as well as exciting games available for your Commodore 16.
- You don't need any additional equipment to use cartridge software. All you do is plug the cartridge into the back of your computer and turn the power on.

Loading Cartridges

- The steps for loading a cartridge are as follows:



- 1 Turn OFF your Commodore 16.



3

USING SOFTWARE

IMPORTANT: YOU MUST TURN OFF YOUR COMPUTER BEFORE YOU INSERT OR REMOVE CARTRIDGES. IF YOU DON'T, YOU MAY DAMAGE THE CARTRIDGE AND THE COMPUTER.

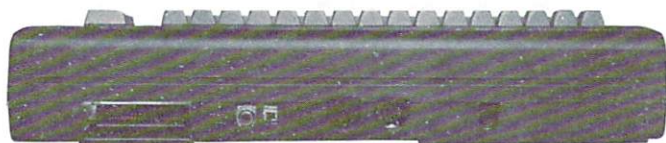
-  2 Hold the cartridge with the label facing UP, and push the cartridge firmly into the cartridge slot (labeled MEMORY EXPANSION) in the back of your computer.



-  3 Turn ON your Commodore 16.
-  4 Begin the game or program according to the instructions that come with the software.

3

USING SOFTWARE

Cassettes



- A variety of programs for the Commodore 16 is available recorded on cassette tape.
- To use cassettes, the only extra equipment you need is a model 1531 Datassette™ tape recorder, available from your Commodore dealer.
- The only step involved in hooking up the Datassette is plugging the cable into the CASSETTE PORT in the back of your Commodore 16.
- You can also use cassette tapes and the Datassette to store programs you write yourself.

NOTE: You MUST use the special Datassette to load or record cassette software, rather than a regular audio cassette recorder.

3

USING SOFTWARE

Loading A Program On Cassette Tape

- The steps for loading a program on cassette tape are as follows:

- 1 Insert the cassette into your Datassette and close the door.
- 2 Rewind the tape to the beginning by pressing the REWIND button on the Datassette.
- 3 Press the STOP button on the Datassette when the tape is rewound to the beginning. Then type **LOAD** and press the RETURN key.

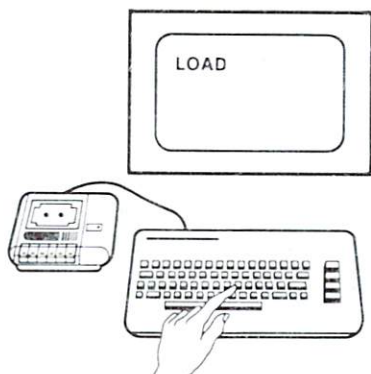

The computer responds with:

PRESS PLAY ON TAPE

- 4 Press the PLAY button on the Datassette. The screen goes blank as the Datassette starts. When a program is found the screen displays this message:

3

USING SOFTWARE

FOUND program name

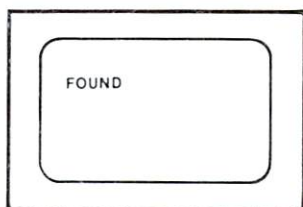

- 5 Press the Commodore key to load the program that was **FOUND**. If there is more than one program on the tape, and the program your Commodore 16 found isn't the one you want, after about 8 seconds (if you don't press the **C** key) the computer keeps searching.

When the program is loaded, the word **READY** appears. If you want to stop the loading before it's complete, press **RUN/STOP** on the keyboard, then the **STOP** button on the Datassette.

After the software is loaded, type **RUN** and press **RETURN** to start the program.

Loading A Specific Program

- To **LOAD** a specific program on the tape, type the name of the program you want after typing **LOAD**. The instructions are the same as typing **LOAD** with no name, with just a few differences.

3

USING SOFTWARE



- 1 If the program you want is called BASES, you would type:

LOAD "BASES"

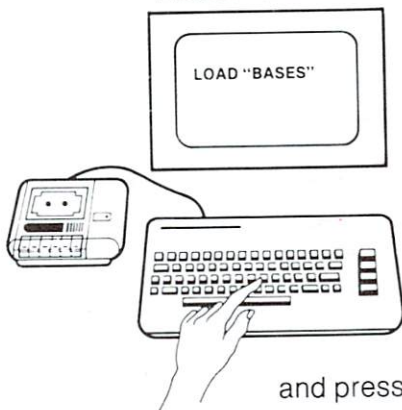

and press RETURN

Make sure you type quotation marks around the name of the program you wish to load.

Your computer responds with:

PRESS PLAY ON TAPE

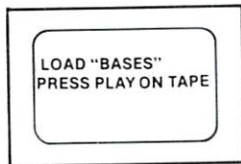

- 2 Press the PLAY button on your Datassette to get your computer to start looking. After searching on the tape for the program called BASES, the message should appear:

3

USING SOFTWARE

SEARCHING FOUND BASES LOADING

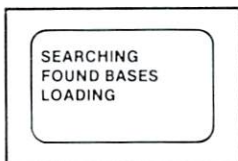

The screen goes blank while your computer then "reads" the program into its memory. Once your computer has digested the entire program, your Commodore 16 tells you:

READY.



3 At the cursor, you instruct it to

RUN

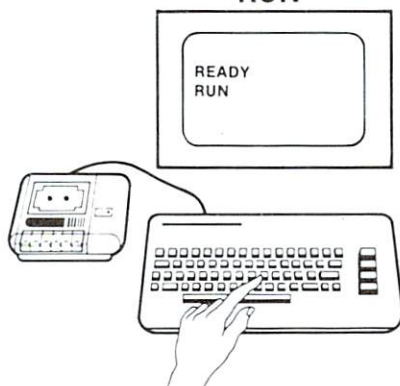

and press **RETURN**. At this point, your Commodore 16 runs (executes) the program "BASES".

If the entire tape goes by without the found message, rewind the tape and try again.

3

USING SOFTWARE

Diskettes



- Disks (or diskettes, or floppy disks) are fast and easy to use.
- To use software on disk, you'll need a Commodore 1541 or 1551 Disk Drive.
- To set up the disk drive, you have to plug its power cord into an electrical socket. The cable that connects the disk drive to the Commodore 16 must be plugged into the SERIAL SOCKET.
- There are two small lights on the front of the disk drive.
 - The green light is the power light, telling you whether the disk drive is turned on or off.
 - The red light tells you two things:
 1. When a program is being LOADED or SAVED, it is lit while the disk is spinning in the drive. When the red light goes off, the LOAD or SAVE is complete.

3

USING SOFTWARE

2. If there is a problem with the diskette or drive, the red light flashes on and off, even after the disk stops spinning in the drive.
- You can also use disks to store programs that you write yourself.
 - Here are the steps to follow to load software from disk:



1 Make sure that your disk drive is ON.



2 Insert the disk into the disk drive. The label side of the disk must face up. Insert the disk into the opening so the labeled end goes in last. Look for a little notch on the side of disk (it might be covered with a sticker). This notch should be to your left as you put in the disk, assuming that you're facing your disk drive. Be sure the disk is in all the way.

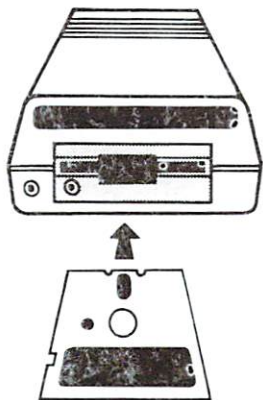

3

USING SOFTWARE



- 3 Close the protective door on the disk drive after you insert the disk.



- 4 Type:
DLOAD "program name" Specific name of the program to be LOADED

(To save time, you could press FUNCTION KEY 2 and type in the program name and the second quote marks.)

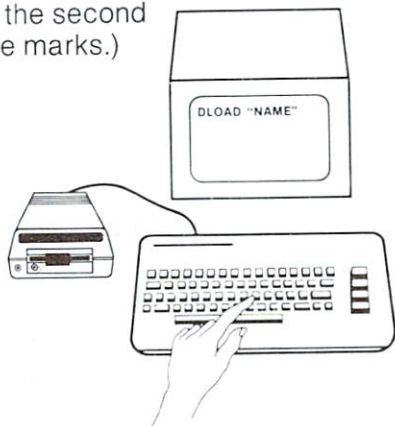

- 5 Press the **RETURN** key. The disk spins and your screen says:

SEARCHING FOR program name

FOUND program name

LOADING

READY.

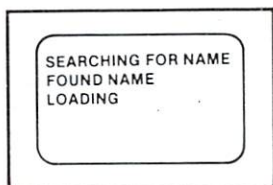

3

USING SOFTWARE



6 Your software is now ready to use. Type **RUN** and press the RETURN key to start the program.

- You have to supply either program name (or a *) in the **DLOAD** command. Follow the instructions that came with the software.
- If the red light on the disk drive blinks after the **DLOAD** is finished, something went wrong. Type:

?DS\$ (and press RETURN)

to find out what went wrong.

Examples of **DLOAD** commands:

DLOAD "*" LOADs the first program on the disk.

DLOAD "FILES" LOADs a disk program called FILES.



4

LEARNING THE BASICs

- Numbers and Calculations
- BASIC Programming
- Sound and Music
- Graphics and Color

4

LEARNING THE BASICs

This is an introduction to let you know something about the BASIC programming language that is included with your computer. This section will begin to give you an idea of what you can do with your Commodore 16. In the following sections, there will be reviews of the BASIC capabilities of your computer for numbers and calculations, sound and music, graphics and color, and programming. These reviews are just introductions; to further your understanding, a more thorough Intermediate User's Manual is available for you when you're comfortable with your Commodore 16, after you've struck up an initial rapport. If you aspire to greater programming heights, the Series 264 Programmer's Reference Guide contains information about the advanced programming capabilities of the Commodore 16.

4

NUMBERS AND CALCULATIONS

- Introduction
- Calculations
- Advanced functions



4

NUMBERS AND CALCULATIONS

You don't have to be a math genius to understand and make use of the mathematical capabilities of your Commodore 16. You can use your computer to perform addition, subtraction, multiplication, division and relational operations ($<$, $>$, $=$), as well as advanced functions like square roots and sines. Your computer understands fractions and scientific notation. You can figure out and use variables. Your computer can handle single-digit whole numbers or complex numbers of up to 38 places in exponential notation with equal efficiency. You can do your calculations directly or as part of programs. You can also design your own equations for your computer to evaluate each time you need the formula applied, without having to retype the whole equation in each instance. Your Commodore 16 is also a random number generator, which is useful in programming.

As a calculator:

- Besides the standard $+$ and $-$ operation signs, your Commodore 16 uses the $*$ sign for multiplication and the $/$ sign for division and fractions.
- To solve a problem, type in **PRINT** followed by the equation. Then press **RETURN** to get your computer to perform the math involved.
- These are the operators you can use:

4

NUMBERS AND CALCULATIONS

Basic Mathematical Operators

Addition	+
Subtraction	-
Division and fractions	/
Multiplication	*
Exponentiation	↑

Basic Relational Operators

Greater than	>
Less than	<
Equals	=
Greater than or equal	= > or > =
Less than or equal	< = or = <
Not equal to	<> or ><

NOTE: Your computer doesn't accept commas as part of a number. For example, you have to type 30359 instead of 30,359. If you put a comma in a number, your computer thinks you mean two numbers (separated by the comma), and would read it as 30 and 359 instead of 30359.

Example: What's 1959 times 33?

To find out, type:

PRINT 1959*33 and press the **RETURN** key

The answer appears right underneath the problem.

- Instead of typing out **PRINT**, you could use a question mark (?), as in:

? 1959*33

4

NUMBERS AND CALCULATIONS

Your computer reads this the same as it would interpret PRINT.

Order Of Calculation

- You can do more than one calculation in one line, like this:

PRINT 200*50 + 5

or this:

PRINT 50 + 5*200

These nearly identical problems give completely different answers. Your Commodore 16 **always** performs calculations in a certain order:

FIRST: Your computer checks for negative numbers (not subtraction, just negative numbers).

SECOND: Your computer solves any exponents.

THIRD: Your computer solves all multiplication and division, from left to right.

FOURTH: Your computer solves addition and subtraction, from left to right.

NOTE: Your Commodore 16 always solves any part of the problem surrounded by parentheses first.

4

NUMBERS AND CALCULATIONS

Advanced Functions

- Your computer can also calculate higher-level mathematical functions when you type in a BASIC numeric function command and the number or variable to be figured out, and press RETURN.
- Numeric function follow this form:

FUNCTION (X)

where the FUNCTION is the specific command and X is the number or variable to be calculated.

Here are the BASIC functions you can use:

- ABS (X)** (absolute value)
- ATN (X)** (arctangent)
- COS (X)** (cosine)
- EXP (X)** (the mathematical constant e (2.71828183) raised to the power of X)
- INT (X)** (integer of X, rounded down)
- LOG (X)** (logarithm)
—To convert to log base 10, divide by LOG (10).
- RND (X)** (generate a random number)
- SGN (X)** (sign: positive, negative or zero)
- SIN (X)** (sine)
- SQR (X)** (square root)
- TAN (X)** (tangent)

4

NUMBERS AND CALCULATIONS

- When you use these functions, remember to type PRINT before the function, like this:

PRINT SQR (16)



4

BASIC PROGRAMMING

- Introduction
- Communicating with your Commodore 16
- BASIC keywords

4

BASIC PROGRAMMING

Introduction

At the heart of the computer is programming. If programming is the heart of the Commodore 16, then BASIC language is the lifeblood. A language is what you use to communicate with your computer. The computer understands the terms (or keywords) that make up the language, and interprets them as instructions. Your computer has a version of BASIC built in called BASIC 3.5. This version contains many terms not found in other BASICs—over 100 keywords in all. In the following sections on Sound and Music and Graphics and Color, you'll see some different BASIC terms being used in different ways.

Communicating With Your Commodore 16

- There are two different ways to communicate with your computer:
 - immediate (directly)
 - in a program (indirectly)
- Direct communication means that you give your orders directly and the computer carries them out right away, like this:

PRINT "ANYTHING"

When you press RETURN, this tells the computer to print what is between the quotes immediately.

4

BASIC PROGRAMMING

- A program features lines of commands, but each line has a number. The number tells the computer in what order to read the program, lowest being read first, such as this:

10 PRINT "ANYTHING"

Nothing seems to happen when you press **RETURN**. The line is entered in the computer, but it doesn't do anything. You need to tell it to execute (or RUN) the program. You do this by typing **RUN** and pressing the **RETURN** key. Then the computer goes through each line in order and carries out what each line tells it to do.

Basic 3.5 Keywords

- The keywords in BASIC 3.5 may be divided into three types:
 - COMMANDS
 - STATEMENTS
 - FUNCTIONS
- Commands are keywords that are most often used in direct communication (with no line numbers). An example of a command keyword is **LOAD**.
- Statements are keywords that usually appear in numbered program lines. **PRINT** is a statement keyword.
- Functions (as shown in the Numbers review) can be used in either fashion. Instead of carrying out a command, the computer returns numbers or letters.

4

BASIC PROGRAMMING

See the Intermediate User's Manual for a thorough review of the BASIC 3.5 keywords and a detailed explanation of their applications. If you are interested in learning how to program with BASIC, there are many good books and tutorials available. There is a book list at the end of this guide, containing many good sources for learning programming.

4

SOUND AND MUSIC

- Volume command
- Sound command
- A sound effect



4

SOUND AND MUSIC

With your Commodore 16, you can design music and sound programs, enhance other programs with music and sound effects, or just play around and experiment with your computer's sound.

- Here's how to play a single note on your Commodore 16:

First: Type **VOL 8** and press RETURN

Second: Type **SOUND 1,266,60** and press RETURN

You should hear a note play for about a second and then stop. If you don't hear anything, turn up the volume of your television or monitor and try it again.

- These two steps are the only commands you need to know to play music on your Commodore 16. Both commands are easy to understand and easier to use.

The Volume Command

- The **VOL** command controls the VOLume of the notes that your Commodore 16 plays.
- The number after **VOL** sets the volume from LOUD (**VOL 8**) to OFF (**VOL 0**).

4

SOUND AND MUSIC

The Sound Command

- The **SOUND** command tells your computer everything it needs to know about the sound you want to play.
- The **SOUND** command is followed by three numbers that describe the note:

SOUND voice, note value, duration

- The first number in the sound command refers to voice. The number for voice can be a 1, 2 or 3. The Commodore 16 sound is produced by two different voices, 1 for the first voice and 2 for the second. The third voice option refers to voice 2's capacity to produce noise rather than a tone. You can use voice 3 to create sound effects like thunder or wind.
- The second number after the word **SOUND** is the note value (frequency).
- This can be any number from 0 to 1023. It tells your Commodore 16 how low- or high-pitched a note to play.
- As the numbers get larger, the notes get higher. The highest values (in the 1023 neighborhood) are not audible to the human ear.

Note: With voice 3, noise is "white" (static) only in the frequency range of 600-940. You can use register value outside this range to create interesting sound effects.

4

SOUND AND MUSIC

This displays all of the notes in one scale, along with the note value to use:

NOTE	A	B	C	D	E	F	G
VALUE	770	798	810	834	854	864	881
ACTUAL FREQUENCY (HZ)	440.4	494.8	522.7	588.7	658	699	782.2

- The third number after the word SOUND controls the duration (length) of the note, telling your computer how long to play the note.
- This number can be anything from 0 to 65535. This number sets a timer, which counts time in 60th's of a second. A duration of 60 keeps the note on for one second.
- The rule of thumb for duration is the larger the number, the longer the note stays on.

A Sound Effect

- Here is a short program to give you an idea of how you can create different sound effects on your Commodore 16. Type it in exactly as it appears here, pressing **RETURN** after each line.

```
NEW
10 VOL 8
20 FOR L = 1 TO 10
30 SOUND 1,466,20
40 SOUND 1,1020,15
50 NEXT L
60 SOUND 3,500,20
RUN
```

This program simulates a busy signal, and the line being disconnected.



4

GRAPHICS AND COLOR

- Graphic characters and animation
- Controlling colors
- Other commands

4

GRAPHICS AND COLOR

Introduction

The old expression, "a picture is worth a thousand words", is appropriate when discussing the graphics and color capabilities of your Commodore 16. Without going into a lengthy explanation of what you can do artistically, this section will review some of the Commodore 16's graphic flair.

Using Graphic Symbols

- Earlier, in Section 2, the graphic symbols were discussed. You can use the symbols to create graphs and figures, as well as more elaborate representations.
- You can simulate animation by alternating graphic symbols or moving a graphic figure around the screen in a program.

Simple Animation

This program simulates animation by alternating the circle (`SHIFT` & Q) and heart (`SHIFT` & S) symbols. If you use your imagination, you could consider this a heartbeat of sorts.

4

GRAPHICS AND COLOR

IMPORTANT TO NOTE: Each time **SHIFT** or **C** appears in the program, it should be typed at the SAME TIME as the key following it when entering the program, since nothing happens when either key is typed by itself.

- Remember to type **NEW** and press **RETURN** before entering each new program, and press **RETURN** to enter each line in all these programs.
- Type this in exactly:

```
10 PRINT = "HOME SHIFT Q"
```

```
20 FOR L = 1 TO 100
```

```
30 NEXT L
```

```
40 PRINT = "HOME SHIFT S"
```

```
50 FOR M = 1 TO 200
```

```
60 NEXT M
```

```
70 GOTO 10
```

```
RUN
```

- To stop this program, press the **RUN/STOP** key.

More Animation

In that program, the object was stationary. To move an object (in this case a ball), just erase the ball and replace it at a new position, as in this program:

4

GRAPHICS AND COLOR

NEW

10 PRINT = " SHIFT CLEAR "

20 PRINT = " SPACE SHIFT Q "

30 FOR L = 1 TO 50: NEXT L

40 GOTO 20

RUN

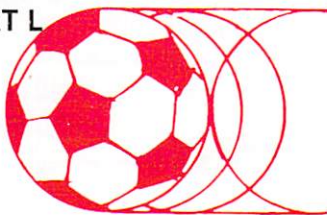

- When you **RUN** the program, remember to press the RUN/STOP key when you want to stop moving the ball.

Controlling Colors

- Separate colors can be put into each part of the screen.
- The border can be one color, the background a different one, and each character can have its own color. You saw in Section 2 how to change the color using the keyboard. You can change the colors of the other screen areas using the BASIC statement **COLOR**. The **COLOR** statement looks like this:
COLOR area, color, luminance
- The first number after the word **COLOR** specifies the area on the screen you want to change. This table lists what each screen area number controls; areas 2 and 3 refer to more advanced multi-color graphics.

4

GRAPHICS AND COLOR

Screen Area Numbers

AREA # AREA NAME

0	Background
1	Character
2	Multi-color 1
3	Multi-color 2
4	Border

BORDER

CHARACTERS

BACKGROUND

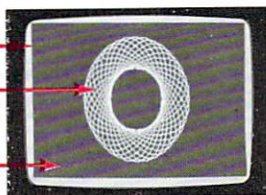

- The second number after **COLOR** selects the color you want to put on the area of the screen you've specified. The color numbers correspond to the color keys on the keyboard.

Color Numbers

#	COLOR	#	COLOR
1	BLACK	9	ORANGE
2	WHITE	10	BROWN
3	RED	11	YELLOW GREEN
4	CYAN	12	PINK
5	PURPLE	13	BLUE GREEN
6	GREEN	14	LIGHT BLUE
7	BLUE	15	DARK BLUE
8	YELLOW	16	LIGHT GREEN

4

GRAPHICS AND COLOR

- The third number refers to an adjustable brightness level, called the *luminance*. You can add a number from 0 (darkest) through 7 (brightest) after the color number to vary the color.

Type:

COLOR 4, 3, 0 and press **RETURN**.

The border becomes a dark red.

Now type:

COLOR 4, 3, 7 and press **RETURN**.

The border changes to bright red.

- The BASIC 3.5 language includes commands that let you create geometrical shapes, lines and dots on the screen.
- Commands like **DRAW**, **CIRCLE**, **BOX** and **GRAPHIC** can be used to create shapes, designs, charts, graphs and figures.
- Other commands such as **PAINT** can be used to color in parts of the screen.

The Intermediate User's Manual, available at your bookstore, contains a complete review and explanation of the commands in your computer's BASIC that are used for graphics and color. The Series 264 Programmer's Reference Guide deals with graphics on a programmer's level.

5

ETC.

- Peripherals
- Books

Peripherals

Peripherals are accessories that increase what you can do with your computer. These accessories are available at your Commodore dealer, and allow you to use your computer to the fullest. Peripherals give you the capability to save and store data, print out on paper, use software programs that are stored on cassette tape and floppy disk, and give you a sharp, clear picture of your computer's display.



To save or recall programs, you'll need a device that stores data. Data can be recorded on and retrieved from both cassette tapes and diskettes. To use cassette tape software (and to record your own programs on cassettes), you'll need the Commodore DATASSETTE tape recorder. For diskettes, you'll want a Commodore DISK DRIVE. Disk drives are typically fast and efficient to use.

ETC.

Model numbers:

Datassette

- 1531 Datassette

Disk Drives

- 1541
- 1551

Your television set may not give you as clear a picture as you'd like for your computer. Commodore color monitors are specially designed to give you the sharpest, brightest picture for viewing your Commodore 16 output.

Color Monitor Model Numbers:

- 1701
- 1702
- 1802/1803

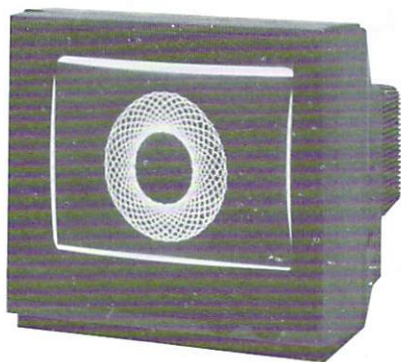

5

ETC.

When using a wordprocessing program or a graphics package on your Commodore 16, a printer will reproduce what is on the screen on paper. There are several models of Commodore printers available that work with your computer. Different printers specialize in different kinds of printing. Ask your Commodore dealer which printer best suits your needs.

Printer Model Numbers:

- MPS-801 (dot matrix)
- MPS-802 (dot matrix)
- MPS-803 (dot matrix with tractor feed)
- DPS-1101 (letter quality)

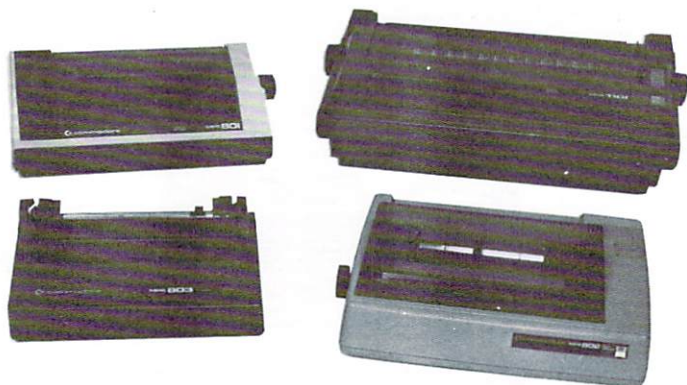

Books for Commodore Products

The following lists include a sampling of the computer and programming books available. The title of the book is listed first, followed by the author and publisher.

Commodore Books

Commodore 16 Intermediate User's Manual

Commodore Series 264 Programmer's
Reference Guide

Mastering Your VIC 20

Four VIC 20 Computer Books:

VIC Revealed, Nick Hampshire

VIC Games, Nick Hampshire

VIC Graphics, Nick Hampshire

Stimulating Simulations for the VIC,
C.W. Engel

Introduction to BASIC, Part 1 and 2, Andrew Colin

Commodore Software Encyclopedia,
Third Edition

BASIC Programming

Armchair BASIC: An Absolute Beginner's Guide
to Programming in BASIC; Fox & Fox,
Osborne/McGraw-Hill

BASIC Handbook, Second Edition; Lien,
Compusoft

Basic Commodore 64 BASIC; Coan, Hayden

Elementary BASIC; Ledgard & Singer, SRA

How to Build a Program; Emmerichs,
Dilithium Press

ETC.

Instant Freeze-Dried Computer Programming
in BASIC; Brown
My Computer Likes Me When I Speak in BASIC;
Albrecht, Dilithium Press
Nailing Jelly to a Tree; Willis & Danley
Dilithium Press
The Programmer's Book of Rules; Ledin & Ledin,
Lifetime Learning Publishers
Technical BASIC; Kassab, Prentice-Hall

Machine Language Programming

Machine Language for Beginners:
Mansfield, COMPUTE! Books
Programming the 6502; Zaks, Sybex
6502 Assembly Language Programming;
Leventhal, Osborne/McGraw-Hill
6502 Micro Chart; Micro Logic Corp.
6502 Software Design; Scanlon, Sams
The 6502 Software Gourmet Guide & Cookbook;
Findlay, Hayden

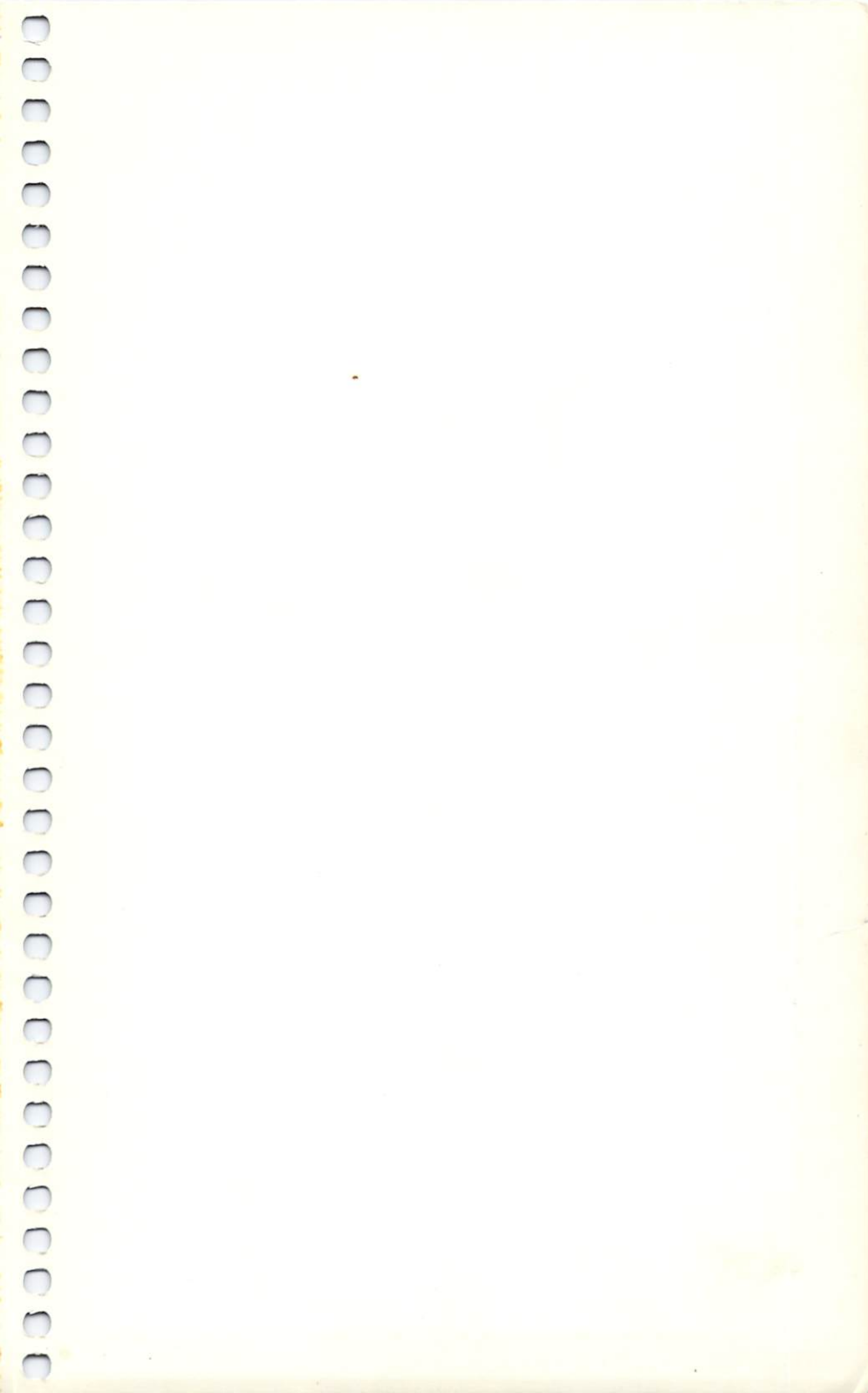



Learning About the "Learning Computer"

The Commodore 16 Owner's Guide is an easy-to-follow introduction to using your new computer. The Commodore 16 is designed to be the "learning computer"—perfect to use to learn about computing. You can use your Commodore 16 to write programs, run software, play games and more.

Using the Commodore 16 Owner's Guide, you can learn about:

- How to set up your computer
- How you can use the different keys
- Different types of software and how to use them
- Different peripherals you can get to expand your computer system

Also, the Owner's Guide will introduce you to the BASIC computer language built into your Commodore 16, used for

- Numbers and calculations
- Writing programs
- Sound and music
- Color and graphics

Included with your computer is a software cartridge, the Keyboard Tutorial Cartridge, which teaches you about using the computer keyboard. This cartridge supplements this Owner's Guide, and comes with its own instructions for use.



Commodore Business Machines, Inc.—Computer Systems Division
1200 Wilson Drive, West Chester, PA 19380