

COMMODORE®

**MODEM
300**

USER'S MANUAL



Your Telephone Resource Center



Your Telephone Resource Center

Modem/300

User's Manual

**For Your Commodore 128™ Computer
Commodore 64® Computer
Commodore SX 64™ Computer
or Commodore VIC 20® Computer**

**Copyright © 1985 by Commodore Electronics Limited
All rights reserved**

**Copyright © 1985 by Microtechnic Solutions, Inc.
All rights reserved**

This manual contains copyrighted and proprietary information. No part of this publication may be reproduced, stored in a retrieval system, or transmitted in any form or by any means, electronic, mechanical, photocopying, recording or otherwise, without the prior written permission of Commodore Electronics Limited.

This software product is copyrighted and all rights reserved by Commodore Electronics Limited. The distribution and sale of this product are intended for the use of the original purchaser only. Lawful users of this program are hereby licensed only to read the program, from its medium into memory of a computer, solely for the purpose of executing the program. Duplicating, copying, selling or otherwise distributing this product is a violation of the law.

CompuServe™ is a trademark of CompuServe, Inc.

QuantumLink™ is a trademark of Quantum Computer Services, Inc.

Commodore 64® and Commodore VIC 20® are registered trademarks of Commodore Electronics Limited.

Commodore 128™ and Commodore SX-64™ are trademarks of Commodore Electronics Limited.

CONTENTS

Section 1

Introduction	1
What a Modem Does	1
What Comes with Your Modem	2
How to Use This Manual	3

Section 2

Connecting Your Modem/300	5
Installing the Modem/300	5
Connecting the Audio System	7
With a Commodore Monitor	7
With a Television Set	7

Section 3

Preparing to Use Your Modem/300	9
Setting the Answer/Originate Switch	9
What You Need to Know About the Host Computer	10
How to Obtain Protocol Information	10
Contacting a Computer at Work or School	10
Contacting an Information Service	10
Contacting another Commodore Computer	11

Section 4

Using the Common Sense Terminal Program	13
Introduction	13
Starting Out	17
Loading the Program	20
Guided Tour	21
The Status Line	21
Modem Setting	26
Keyboard Functions	27
Split-screen Typing	27
Printer Functions	28
Disk Functions	29
Screen Editor	30

Disk Wedge Commands	30
Autodial Functions	33
Screen Control Functions.	33
File Transfer Protocols	34
Reference.	35
Command Index	35
Command Reference	36
CHANGE.MTS.	44
Setting up Multiple Drives.	45
 Section 5	
Using the VT100 Terminal Emulator Program.	47
What Is a Terminal Emulator	47
How Terminal Emulators Are Used	47
VT100-128.	48
 Section 6	
Technical Information	59
 Section 7	
Troubleshooting.	63
Connection Problems	63
Terminal Mode Problems.	63
Customer Support.	64
 Appendix	
Advanced BASIC Programming for your Modem/300.	65
 Federal Communication Commission Statement	71
 Glossary.	75

Section Introduction

The Commodore Modem/300 is a compact, powerful computer device that lets you communicate instantly with other computers over ordinary telephone lines.

Your Commodore Modem/300 gives you direct access to the wide range of information available on many information services, both national and local. You can play games against distant opponents, obtain the latest stock quotes and news, check airline schedules, send and receive mail electronically—and much, much more. With appropriate software, you can also take advantage of the auto-answer feature of the Modem/300 and turn your Commodore computer into an electronic “bulletin board” system.

WHAT A MODEM DOES

A computer uses a type of electrical signal called **digital**. Telephones use a type of electrical signal called **analog**. When you are sending information to another computer, your Modem/300 converts your computer's outgoing digital signals to a modulated analog signal that can be transmitted over the telephone line. When you are receiving information, the modem converts (demodulates) the incoming analog signals to digital signals that are understood by your computer.

The term modem was created by combining the first parts of the words MOdulator/DEModulator.

Your Modem/300 is an “auto-modem”. The Modem/300 is controlled by your computer and can dial a specific phone number, detect a remote computer's signals and establish a connection to your computer, or answer incoming calls from other computers. In addition, it uses the audio system of your monitor or television set to let you listen to a connection in progress, so you will know if you reach a busy or incorrect number.

The software disk included with your Modem/300 includes several terminal programs which may be used with your Modem/300. Your Commodore computer requires a terminal program in order to control your Modem/300 and to communicate with other computers.

WHAT COMES WITH YOUR MODEM

Carefully unpack your modem if you have not already done so. Examine the package contents. Your Commodore Modem/300 comes with a modular telephone cord, a DIN to RCA cable, a Y-adapter (see photos below), a disk containing several communications programs, and a special offer from the QuantumLink™ personal computer network. If you do not have all of the items listed, you should immediately contact the dealer from whom you bought your Modem/300.

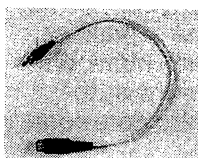

1 DIN-to-RCA
Cable

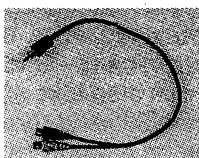

1 RCA
Y-Adapter

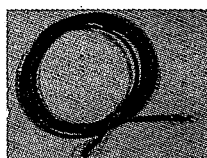

1 Six-foot Modular
Telephone Cord

QuantumLink, which is accessed using special communications software included on your disk, is a personal computer database offering features designed to appeal to Commodore users. For a flat monthly subscription rate, you can access a number of services which allow you to download and save hundreds of unpublished programs, post messages on electronic bulletin boards, play entertaining games, order products, carry on conversations with other computer owners, look up references in an electronic encyclopedia, and more. Detailed instructions for using QuantumLink are contained in a separate manual.

Also included on the program disk is a general purpose terminal program for the Commodore 64 and 128 called Common Sense, which enables you to communicate with many other information services and other personal computers. Section 4 of this manual describes the functions of the Common Sense program. A VT100 Terminal Emulator for use in the 80-column mode of the Commo-

dore 128 is also provided; instructions for using this program are found in Section 5.

HOW TO USE THIS MANUAL

If you have little or no previous experience with modems and computers, you should read this manual completely. If you have had previous experience with modems, the following section-by-section summary of the contents should allow you to locate any specific information you may need.

Section 2, Connecting the Commodore Modem/300, provides step-by-step instructions for connecting your modem to a Commodore computer.

Section 3, Preparing to Use Your Modem/300, describes how to obtain information you'll need prior to using your modem.

Section 4, Using the Common Sense Terminal Program, contains descriptions of the variety of functions that can be performed using the Common Sense terminal software.

Section 5, Using the VT100-128 Terminal Emulator Program, describes how to use this program to convert your computer to an intelligent terminal.

Section 6, Technical Specifications, gives technical information about the Modem/300 for the advanced user.

Section 7, Troubleshooting, provides help if you have problems using your Modem/300 or connecting to an information service.

Appendix A, FCC standards, describes the Federal Communication Commission regulations regarding use of modems with personal computers.

Appendix B, Advanced BASIC Programming, provides information for persons developing their own telecommunications software.

A **glossary** is included to provide definitions for telecommunications and technical terms used in this manual.

Section **Connecting Your Modem/300**

This section explains how to connect the Commodore Modem/300 to your computer, to the telephone lines, and how to connect the audio system.

The following instructions assume you have already connected and used your computer, disk drive and monitor or television set. There are two stages to the connection:

1. Installing the modem and telephone lines
2. Hooking up the audio system so you can hear the phone ringing

Instructions for hooking up the audio system vary between systems with a Commodore monitor, and systems with a television set. Be sure to read and follow the instructions appropriate for your equipment. The VIC 20 does not use an audio system at all.

Before you begin, re-read the paragraphs in Section 1 entitled "What Comes With Your Modem to be sure you have all the necessary cables and connectors. If you will be using a television set you will also need the long RCA cable that was supplied with your computer.

1) INSTALLING THE MODEM/300 AND TELEPHONE LINES

Before you install the modem, locate the two square telephone jack receptacles marked LINE and PHONE. Also locate the single round receptacle marked AUDIO IN, and the answer/originate slide switch labeled A and O.

- a. Turn off the computer, the disk drive, and the monitor.

- b. Locate the user port on the computer. It is a slit several inches long, with exposed metal contacts. Although the user and cartridge ports are similar in appearance, your Modem/300 will not fit into the cartridge port of your computer.
- c. Insert the smaller end of the Modem/300 into the user port. Insert the modem firmly, but do not force it in, as this can damage the connectors.
- d. Remove your telephone's connector from the wall jack, or locate a telephone wall jack not in use. If your telephone's connector is a modern modular-style plug, squeezing the connector's plastic locking tab will allow it to slip out of the wall jack.
- e. Locate the telephone cord supplied with your Modem/300. Compare the modular connectors on this cord to the telephone connector you just removed from the wall. If they are not the same, an adapter must be used to connect your Modem/300 to the telephone line. These low-cost adapters may be obtained at most electronic stores.
- f. Insert one end of the telephone cord provided with your Modem/300 into your telephone wall jack, using an adapter if necessary. Insert the other end into the modem receptacle labeled LINE.

Note: You may leave your Modem/300 permanently connected to the telephone line, and still continue to use your telephone when the modem is not in use. Plug your telephone's modular plug (that you removed from the wall in step **d**) into the modem receptacle marked PHONE. Now the telephone will operate normally when the modem is not being used.

If you intend to use a Commodore monitor with your Modem/300, follow the set of instructions labeled 2a. If you use a television, follow the instructions labeled 2b.

2a. CONNECTING THE AUDIO SYSTEM WITH A COMMODORE MONITOR

Note: You will not use the DIN-to-RCA cable.

- a. Locate the audio/video cable connected to the monitor. It will be a cable with two or three colored connectors. Unplug the white (audio) portion of the cable from the monitor.
- b. Insert the largest connector of the Y-adapter into the empty socket you created in step a.
- c. Insert the white audio plug (that you removed from the monitor in step a) into either available end of the Y-adapter.
- d. Locate the RCA cable supplied with your computer. Both ends of this cable are identical. Insert one of the ends of the RCA cable into the last available end of the Y-adapter.
- e. Insert the other end of the RCA cable into the jack labeled AUDIO IN on the back of the modem.

2b. CONNECTING THE AUDIO SYSTEM WITH A TV SET

Note: You will not use the Y-adapter

- a. Locate the DIN-to-RCA cable supplied with your modem. Insert the DIN connector (the larger end) into the port labeled VIDEO on the back of the computer.
- b. Plug the RCA end of the DIN-to-RCA cable into the modem receptacle labeled AUDIO IN.

After the modem is installed and the cables attached, turn on the computer, the disk drive and the monitor or TV set. Your Modem/300 is now ready to use. See Figure 2-1 for connection diagram.

Hooking up a Modem/300 (1660)

With a TV Set:

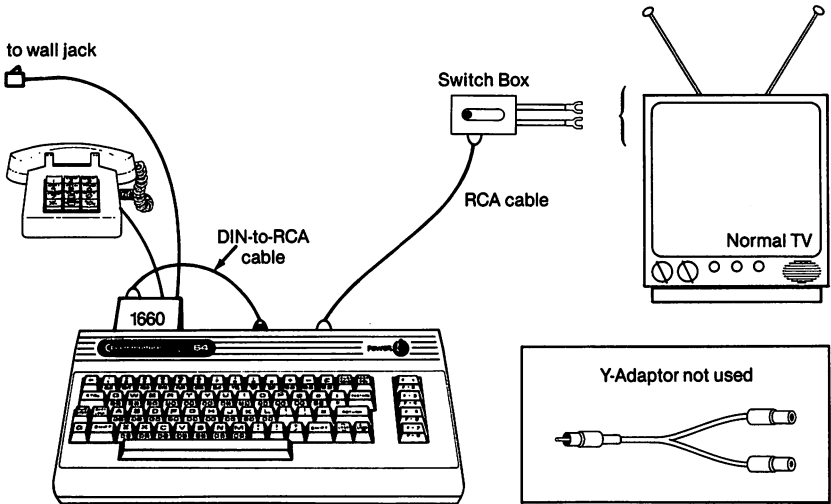

With a Monitor:

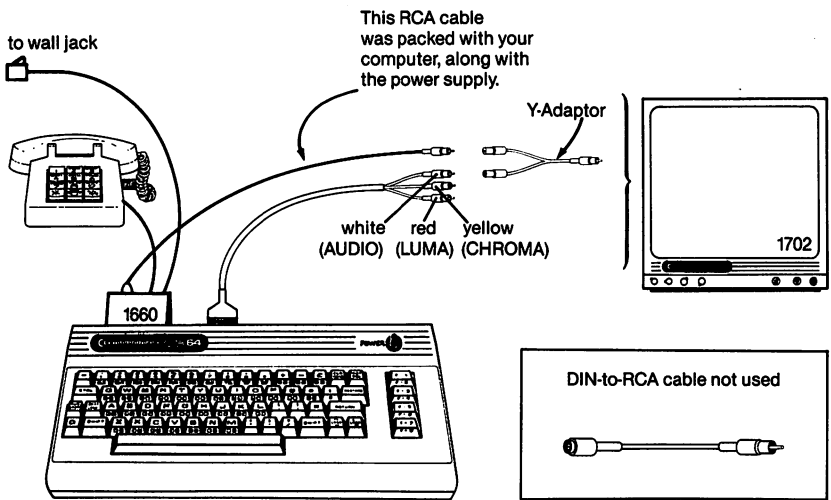

Note: RCA cables are available at most electronics stores.

FIGURE 2-1.
CONNECTION DIAGRAM

Section 3 Preparing To Use Your Modem/300

Before you can begin telecommunicating there is certain information you must obtain. Read this section carefully and do not try to use your Modem/300 until you have followed the instructions printed here.

With your Modem/300 you have access to a large number of information networks and other databases that can bring a tremendous amount of information into your home. You can also communicate with other Commodore computers, or computers in your school or business. The computer you contact—whether it is an information service, a private network, a mainframe at work or another Commodore personal computer—is referred to as the **host**. Your computer is considered the **remote**.

SETTING THE ANSWER/ORIGINATE SWITCH

When you are calling another computer (you are acting as the remote) you must set the switch on the side of the Modem/300 to **O** for originate. Turn all equipment off before setting the switch.

When you are receiving a call from another computer, this switch must be set to **A** for answer.

WHAT YOU NEED TO KNOW ABOUT THE HOST COMPUTER

Each computer system has its own protocol, or rules for communication. You must know the protocol for the system you are contacting, in order to make adjustments to the way your modem sends information. If the protocol of your computer does not match the host, telecommunication will not be successful. You can change the way your computer system transmits information, however, so that almost any host computer can be contacted.

A protocol consists of several parameters (settings). Check the glossary for brief definitions of baud, duplex, line feed, parity, stop bits, and word length.

HOW TO OBTAIN PROTOCOL INFORMATION

Contacting a Computer at Work or School

If you will be contacting a computer, especially a mainframe, at your business or school, the computer operator can help you. Usually a phone call to the computer operator will supply the details you need.

Communicating with an Information Service

You must usually obtain a subscription to the information network you want to correspond with. Sometimes there is an initial fee, and usually an hourly on-line rate. The literature you receive with your initial subscription usually contains the necessary protocol information.

Enclosed with your Modem/300 is a package containing details about membership in the QuantumLink Personal Computer Network with instructions for obtaining a user i.d. code and password. The protocol for contacting QuantumLink is part of the QuantumLink software; you don't have to be concerned with the parameters.

Communicating with Another Commodore Computer

When you contact another Commodore computer system with a modem, use the following parameters:

Duplex:	Half
Line feed:	No
Stop bits:	1
Parity:	None
Baud rate:	300
Word length:	8

Notice that because both computers communicate in Commodore ASCII, the full Commodore character set will be available to you for telecommunication.

Once you have registered with the information networks, or determined the protocol of any other system you want to communicate with, your telecommunicating can begin.

Section **4** Using the **Common Sense Terminal Program**

INTRODUCTION

Requirements

Welcome to the exciting world of telecomputing! Now your Commodore computer can reach out for you to a vast body of information, programs, and new people with similar interests. **COMMON SENSE** can connect you to computers of all sizes, from large database mainframes, minis, micros, and laboratory equipment either through modems or directly connected. The minimum equipment required for operation of this software is a Commodore 64 computer, single disk drive, modem, and TV or monitor. Also supported are serial printers, and an additional disk drive (or dual-drive).

Modems supported fall into three main categories: manual, programmable (automodems), and smart. The manual modem requires you to dial/answer the phone and physically connect the modem to the phone line. Smart modems perform all phone operations independently, communicating to your computer with their own internal computers. **COMMON SENSE** supports all popular manual, direct-connect automodems, and smart modems as of the date of printing.

How you use **COMMON SENSE** depends on your telecomputing need(s). You should obtain the requirements of your host computer system listed below. Try the default settings if you are not sure.

Baud-Rate	300
Number of Stop Bits	1
Word Length	8
Parity	None
Duplex	Full

Attention Procedure
Log-On Sequence
Prompt or Continuous Uploads
Protocols

These factors influence your ability to successfully connect to your intended remote computer. This information should be readily available at the data center or information service. Taking the time now to prepare for using **COMMON SENSE** will save you hours of aggravation and phone charges later. Most public information networks will operate with the default settings in the program.

Equipment Supported

Commodore 128 in 64 mode
Commodore 64
1571 Disk Drive (device 8-11)
1541 Disk Drive (device 8)
2nd 1541 Disk Drive (device 9-11)
4040 Disk Drive
1525 and 1526 Printers
Transparently-connected ASCII Printers
1600 Vicmodem
1650 Automodem
1660 CBM 300 Modem
1670 CBM 1200 Modem (Smart)
All RS232 smart modems
VIC 1011 A RS232 Terminal Adapter

NOTE

Before you use your **Common Sense**, or **VT100** programs, we recommend that you copy these programs onto a separate blank disk. This will provide you with additional disk space for your own text and program files, and prevent damage to the special **QuantumLink** software included on your software diskette. A file copy utility, called **MAKEDISK**, is provided on the diskette. To use this utility, type:

LOAD"MAKEDISK",8 (in 64 mode)

When the computer responds with the word **READY**, enter "**RUN**". Then follow the prompts to copy the appropriate files to a new diskette.

NOTE: Be sure to use a blank diskette as the **DESTINATION**, or files previously stored on this diskette will be destroyed by **MAKEDISK**.

COMMON SENSE contains many features and options which condition its operation to your requirements. The descriptions for using these features are described in later sections; here we will review the options available to you.

- ✓ **Alpha Shift Lock.** You can lock the keyboard into upper case with the software lock, allowing normal transmission with the other keys.
- ✓ **Autodem commands.** You can dial and answer autodem. **COMMON SENSE** lets you store telephone numbers, and dial them automatically.
- ✓ **Buffer Control.** The virtual screen stores (text) data which you have received. You can scroll forwards and backwards to view the text and you can save its contents to disk and/or print it directly. You name the file (or you can use the default name).
- ✓ **Control codes.** The standard control codes are available on the keyboard, using the CTRL key.
- ✓ **Conversions.** The **COMMON SENSE** program disk contains utility routines for converting programs to/from text/program formats, for transferring programs with computers which don't support XMODEM.
- ✓ **Extract/review.** This feature allows you to download text into your buffer, review it on the screen, and produce new files containing just the information you want to retain.
- ✓ **Disk commands.** You can enter DOS wedge 5.1 disk commands for direct control of disks and files. All commands except load and save can be executed.
- ✓ **File transfers.** You can upload and download ASCII/PET ASCII text and program files, using text, XMODEM, or CompuServe™ 'B' Protocol modes.
- ✓ **Upload control.** Files can be uploaded in a continuous stream, with or without user programmed inter-character and/or end-of-line delays.

- ✓ **Bell.** The program will respond to receipt of a CTRL-G (ASCII 7) by sounding a bell. Please note that you must be using a television or a monitor with sound to hear the bell.
- ✓ **Modem control.** You can set any of the factors for the modem, including parity, number of stop bits, word length, baud rate, duplex mode and handshake. You can also “fine-tune” the computer’s internal baud rate to your modem for optimum performance. This fine tuning is most noticeable at 1200 baud.
- ✓ **Function Keys.** You can pre-program function keys f1–f8 and C~~r~~1–C~~r~~8 to send line(s) of text—up to 80 characters per key. The keys can be loaded with new definitions from disk. This is where you may store telephone numbers and other frequently used commands.
- ✓ **Screen print.** You can “snapshot” your screen to the printer—useful for quick hardcopy.
- ✓ **Translation control.** You can control whether translation to/ from standard/PET ASCII takes place. The translation tables themselves are stored on the User Disk, and can be changed for special requirements (even simple data encryption for transmitting coded messages).
- ✓ **Colors.** You select the colors for the screen, border, character and status line/cursor. This feature can be useful even on monochrome monitors for improving contrast.
- ✓ **Linefeeds.** You can toggle to linefeed mode where the carriage return will also send a linefeed when you are communicating with systems that require a linefeed.
- ✓ **XMODEM.** This popular protocol for transferring programs and other data provides compatibility with many personal computers.
- ✓ **‘B’ Protocol.** Error free file transfers to/from CompuServe.
- ✓ **Printer control.** You can define printer type, preset escape commands to ASCII printers, and select linefeeds after carriage return.
- ✓ **Clock.** The program continuously displays time of day in the lower right corner of the screen with a 24 hour clock.
- ✓ **Screen search.** You can search the 700 line virtual screen for specific text.

- ✓ **Split Screen.** You can enter your text in a separate 80 column area while data from the host is being received. This is invaluable for Conference mode on a multi-user service, or when you are in direct contact with another person and typing back and forth.
- ✓ **Screen Editor.** A built-in screen editor allows you to compose messages for transmission. You can also edit received text before saving to disk or retransmission.
- ✓ **Scrolling.** Fast forward and reverse scrolling on the 700 line virtual screen permits you to review text effortlessly.

STARTING OUT

Keyboard Data Entry

The following definitions will apply throughout this chapter:

PRESS: Means depress and release the single key or key combination following the colon.

EXAMPLE: **PRESS: A**
(depress and release the A key)

EXAMPLE: **PRESS: (RETURN)**
(depress and release the (RETURN) key)

DO NOT USE THE (SHIFT) KEY UNLESS IT IS SPECIFIED

EXAMPLE: **PRESS: (SHIFT)A**
(Hold down the (SHIFT) key then depress and release the A key and then release the (SHIFT) key)

(The **COMMODORE C** and the **CONTROL (CTRL)** keys shall be used like the shift key)

EXAMPLE: **PRESS: C&A**
(Hold down the **COMMODORE** key then depress and release the A key and then release the **COMMODORE** key)

EXAMPLE: **PRESS: (CTRL)A**
(Hold down the **(CONTROL)** key then depress and release the A key then release the **(CONTROL)** key)

EXAMPLE: **PRESS: nn**
(press two numeric keys, 00 through 99)

ENTER: Means press the characters after the colon and then depress and release the (RETURN) key.

EXAMPLE: ENTER: A
(press the A key then press the (RETURN) key)

EXAMPLE: ENTER: ABC
(first press the A key then the B key then the C key and finally the (RETURN) key)

Certain numeric entries have a somewhat modified form of the **ENTER:** command.

EXAMPLE: ENTER: ####
(press at least one or up to four numeric keys, if less than four numeric keys pressed then press the (RETURN) key)

TYPE: Means you should type in the desired multiple characters indicated after the colon. You may use the (DEL) key to correct errors as long as you have not pressed (RETURN).

TYPE: <FILENAME> Type in a valid filename in place of the word **<filename>**

EXAMPLE: TYPE: <filename> PRESS: (RETURN)
(type in a valid disk file name then press the (RETURN) key)

EXAMPLE: TYPE: <phone#> PRESS: (RETURN)
(type in a desired phone number in place of the word **<phone#>**. You may include text in your phone numbers for reference but only numeric data will be dialed. Commas may be imbedded as desired to create delays in the dialing sequence. There will be a one second delay for each comma.)

EXAMPLE: TYPE: <string>
(type in a string of desired alpha-numeric characters in place of the word **<string>**.)

<hh> Means you should type two numeric characters representing the desired hour digits in 24 hour format.

<mm> Means you should type two numeric characters representing the desired minutes digits.

<ss> Means you should type two numeric characters representing the desired seconds digits.

EXAMPLE: TYPE: <hh><mm>
(type in the four numeric characters representing the

desired time in 24 hour format. 2:30 PM would be typed as 1430 and 7:00 AM would be typed in as 0700)

EXAMPLE: TYPE: <hh>:<mm>:<ss>
(type in the six numeric characters and the two separating colons representing the desired time in 24 hour format. 2:30 PM would be typed as 14:30:00 and 7:00 AM would be typed in as 07:00:00)

<f1>-<f8> Means to press one of the function keys on the right side of the keyboard. To access function keys <f2>, <f4>, <f6>, or <f8> you must first depress and hold the (SHIFT) key and then press and release the desired function key and then release the (SHIFT) key.

EXAMPLE: PRESS: <f1>
(depress and release function key <f1>)

EXAMPLE: PRESS: <f4>
(depress and hold the (SHIFT) key then depress and release function key <f3> and then release the (SHIFT) key)

<SCROLL> Means you should use the combination of the **C** key and the function keys to access the desired lines on the virtual screen. To access the scroll functions depress and hold the **C** key and then depress and release the desired function key and then release the **C** key.

EXAMPLES:
PRESS: C<f1> to scroll the screen UP one line.
PRESS: C<f3> to scroll the screen DOWN one line.
PRESS: C<f5> to scroll the screen UP one page.
PRESS: C<f7> to scroll the screen DOWN one page.

Special Characters Available

PRESS: (SHIFT) +	For left brace {
PRESS: (SHIFT) -	For right brace }
PRESS: (CTRL):	For ESCape
PRESS: (CTRL)<Char>	For Control characters
PRESS: (CLRHOME)	For alternative Control-q
PRESS: (CRSR-down)	For alternative Control-q
PRESS: (RUNSTOP)	For alternative Control-c
PRESS: (CTRL)g	For remote bell (transmitted)
PRESS: (<-)	For underline _
PRESS: (£)	For backslash \

Special Notation Used in this Section

C	Commodore key
a	C and "a"
(a)	Reversed "a"
(RETURN)	The key indicated in parentheses
<f1>	The key indicated in angle brackets
[...]	Optional input

LOADING THE PROGRAM

NOTE: If you are using a Commodore 128 personal computer, you must be in 64 mode for **COMMON SENSE** to operate correctly.

1. To Load **COMMON SENSE** insert the **System Disk** into Device 8 (Drive 0 if dual drive)
2. **ENTER: LOAD"BOOT",8**
3. When the computer responds with the word **READY**
4. **ENTER: RUN**

Use the color bars displayed on the title screen to adjust the brightness, contrast, color level and tint on your TV/monitor.

5. **COMMON SENSE** is ready for use when the 24 hour clock is running in the lower right hand of the screen.

If you have a dual drive and/or multiple single drives please refer to "SETTING UP MULTIPLE DRIVES" on page 45 of this manual.

COMMON SENSE also loads in the printer parameters on boot-up. The definition of the printer parameters may be changed by modifying the appropriate parameters in lines 220 through 320 in the **BOOT** program.

COMMON SENSE can be customized by the user by changing the default parameters that are located in the **BOOT** program. The parameters that can be adjusted and the appropriate line numbers are:

Screen Colors	210
Printer settings	220-320
Disk device numbers	330-360
Clear Screen (Buffer)	380
Modem type	390-400

You can make your changes permanent. We suggest that you do not alter the original program disk. Use a back-up copy of the program disk instead. See the note on page 14. Save your modified BOOT as follows:

ENTER: SAVE“MODBOOT”,8

GUIDED TOUR

Please read “STARTING OUT” and “LOADING THE PROGRAM” before starting on this guided tour. Follow the procedures described there for modifying the BOOT program. Once you have done that we will be ready to begin.

Now let’s load the program

ENTER: LOAD“BOOT”,8 or “MODBOOT”,8
ENTER: RUN

The screen will “black out” and then the title screen will be displayed. After a period of time, the title screen will be replaced by the main program screen 1. **PRESS: <f1>** to view help screens. This main screen contains a 23-line viewing area and a 2-line status area. Turn to “**COMMON SENSE STATUS LINE**” to verify what should now be displayed on your monitor. We will examine the status line first before we proceed further.

The Status Line

The bottom row contains permanently displayed information as well as a number of “toggle” indicators. A toggle is a status or condition that alternates between two states: “on” and “off.”

Reading the status line from left to right as it now appears, we see:

**FIGURE 4-1
THE STATUS LINE**

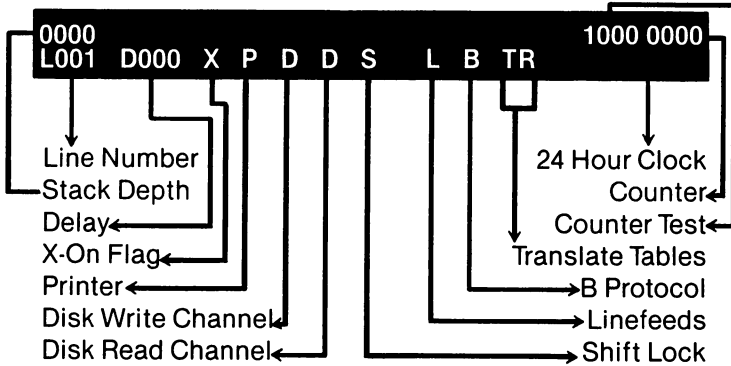

L001

This is the current line number of screen 1. The current line number refers to the location of the cursor, that little “box” now showing at the bottom left corner of the viewing area. Let’s see how it changes by using the scroll keys.

THE SCROLL KEYS

PRESS: ⌘(f1)

Notice that the information in the viewing area “moved up” one line. What has really happened is that the viewing window into the virtual screen buffer has “moved down.” Now the current line number is 25.

PRESS: ⌘(f3)

The information in the viewing area “moved down” one line, and the current line number is again 24. Once again, the window has “moved up.”

PRESS: ⌘(f5)

The whole viewing area “moved up” one complete page (23 lines) as the window moved “down.” Now the current line number is 47.

PRESS: ⌘(f7)

Our original information is now back in view, and the line number is back to 24. You can see then that the line number is your visual

guide to your current location within screen 1. The scroll keys let you traverse the 700 lines in screen 1 quickly and easily.

**FIGURE 4-2
VIRTUAL SCREEN SCROLLING**

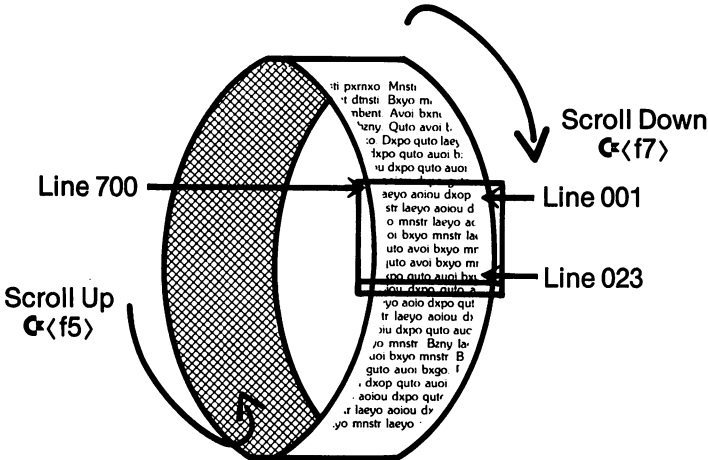

THE DELAY FACTORS

Proceeding along the bottom line, the next field displayed is **D000**. This is the “delay factor” indicator, which tells you (1) the delay time between transmitted characters in thousandths of a second (milliseconds) and (2) the delay time after carriage return in seconds. These factors can be important when sending information from screen 1 or disk to a remote computer because many computer systems can’t process information as fast as **COMMON SENSE** can send it. The **D** indicates that the factor displayed is the time between characters. **PRESS: C-U**. Notice that the **D** is replaced by a checkmark (✓). The ✓ indicates that the factor now displayed is the time after carriage return. Let’s actually change the delay factor after carriage return. **PRESS: C-D**. The top status line has now been replaced by a prompt: **ENTER DELAY FACTOR:** (this line is also your prompt line). **ENTER: 5**. The top status line returns, and the delay factor now displays ✓005 indicating 5 seconds after carriage return. Now, **PRESS: C-U**, then **PRESS: C-D**, then **ENTER: 20**. Now the

display shows **D020**, indicating 20 milliseconds between characters. Once more, **PRESS: C-U**. This time **PRESS: C-D** then ENTER: 1 for a delay after carriage return of 1 second.

B PROTOCOL INHIBIT

The next item displayed on the bottom status line is a **B**. This is the **B Protocol Inhibit** toggle. When the B is displayed, B Protocol is enabled; when it is not displayed B protocol is inhibited. The key combination for this toggle is **C-I**. Try it. **PRESS: C-I**. The B has disappeared, indicating that **COMMON SENSE** will ignore B Protocol signals. Use this setting when you are not communicating with CompuServe to prevent misinterpretation of information from the remote computer. The inhibit is automatically toggled into the inhibit setting whenever a B Protocol transfer with CompuServe is aborted to prevent possible program hang-up.

TRANSLATION TABLES

The next items displayed are the Transmit Translate (T) and Receive Translate (R) toggles. These toggles control how the program treats information to and from the modem. When the Transmit toggle is on, all data being sent to the modem is assumed to be in PET ASCII form and is translated to industry-standard ASCII. Similarly, when the Receive toggle is on, all data received from the modem is assumed to be in industry-standard ASCII and is translated to PET ASCII. **PRESS: C-E** to toggle the Transmit Translate. **PRESS: (SHIFT)E** to toggle the Receive Translate. Now both the T and R have disappeared. **PRESS: C-E** to turn Transmit Translate back on; then **PRESS: (SHIFT)E** to turn Receive Translate back on.

REAL-TIME CLOCK

The last item on the bottom status line is the real-time clock. The clock uses 24-hour time so that you can accurately distinguish between AM and PM. You will note that it may not as yet contain the correct time. Let's set it now. **PRESS: C-T**. Notice that the cursor is positioned to the hours in the clock: TYPE the hours as two numeric digits. Now the cursor is positioned to the minutes: TYPE the minutes as two numeric digits. The top status line returns and the cursor is back to its normal location. Now the clock is set to the correct time.

X-ON/X-OFF

There are a number of other toggle indicators which may display on the bottom line. Immediately to the right of the delay factor is the

indicator for X-ON/X-OFF. **PRESS: (HOME)**. Notice that a reversed @ now displays. This indicates that transmission is now inhibited. X-ON (also known as CTRL-S) is used between computers to temporarily stop transmission. The HOME key sends this signal. Now **PRESS: (CURSOR DOWN)**. The @ disappears. The CURSOR DOWN key sends the signal to resume transmission. This signal to resume transmission is called X-OFF (or CTRL-Q). This toggle will activate automatically for various functions between your computer and the remote computer. Check for a reversed X whenever your keyboard does not appear to work. See page 44 on using **CHANGE.MTS** for disabling these signals in the translate tables.

DISK/PRINTER STATUS

The next three indicators are used to display open status for your printer and disk. You activate these devices with the Disk I/O key command (C-O) and the Printer I/O key command (C-P). **PRESS: C-O** or **PRESS C-P**.

C-O	1 = WO	OPEN Disk Write Channel	(Write Open)
	2 = WS	SUSPEND Disk Write	(Write Suspend)
	3 = WC	CLOSE Disk Write Channel	(Write Close)
	4 = RO	OPEN Disk Read Channel	(Read Open)
	5 = RS	SUSPEND Disk Read	(Read Suspend)
	6 = RC	CLOSE Disk Read Channel	(Read Close)

When you press C-P, only a P appears on the status line to indicate the printer is open and ready to receive data. **PRESS: C-P** again to close the printer.

The Open commands activate the I/O channel for the device specified as well as actually opening the device. The Suspend commands for the disk files leave the channel open, but toggle actual data transfer on and off. This toggle action means that you can control data reading and writing without having to constantly open and close the device. We will experiment with these actions later, so for now just **PRESS: (RUN/STOP)** to abort the I/O Command.

ALPHA SHIFT/LOCK

PRESS: (SHIFT)<UP-ARROW>. An S appears on the bottom line to indicate that letters will be shifted to upper case without using the shift or shift/lock keys. **PRESS: (SHIFT)<UP-ARROW>** again to return to normal typing mode.

LINEFEED MODE

The final toggle on the bottom line is the Linefeed Mode. This is used to send a separate linefeed character to the remote computer every time you press (RETURN). To turn it on, **PRESS: C-L**. You would normally only use this for communicating to remote computers or telecommunications devices that require the separate linefeed character, such as teletype equipment.

Modem Setting

At the top you can see that **C-M** is used to access and set the modem parameters. Do that now: **PRESS: C-M**. Above the status line is displayed the current modem setting. In the middle of the line is a description of which parameter is currently active for your adjustment: it should say baud rate. You use the Cursor Right key to cycle through the various parameters.

Try it: **PRESS: <CURSOR RIGHT>** once. Now the description is duplex. The duplex setting is currently **F** for Full Duplex. Since we're going to want to be in half duplex mode to complete our guided tour, let's change the duplex setting. **PRESS: <CURSOR DOWN>**. The **F** in the modem setting changed to **H** to indicate Half Duplex.

All the parameters in the modem setting work this way: use the Cursor Right key to select the parameter you want to change, then use the Cursor Down to cycle through the allowable settings for the selected parameter.

Now **PRESS: <CURSOR RIGHT>** until the prompt says baud rate again. The baud rate has a special adjustment in addition to the normal settings: you can use (+) and (-) keys to "fine tune" the baud rate. This is normally only useful for 600 baud or greater, and it adjusts the precise timing between a Commodore computer and your modem to account for slight timing differences between modems. **PRESS: +**. The Baud Rate Factor (BRF) on the right side of the line now displays 1606. **PRESS: -**. The BRF is now 1605 (this is the normal factor for 300 baud).

After the modem is set the way you require, **PRESS: (RETURN)**. Do it now: the top status line returns. **PRESS: C<f5>** to see the second half of the modem help file. This screen explains the use of the Baud Rate Factor. The modem help file also describes how to set the modem through a direct command without using the Cursor Right/Cursor Down sequence.

Keyboard Functions

COMMON SENSE uses the standard ASCII symbols rather than the Commodore symbols when displaying information. Other keys are also redefined: **PRESS: (BACK-ARROW)** and you will see an underscore on the screen. Also note that the up-arrow is replaced with a caret (^). A very useful feature of the program is its ability to perform high-speed searches through the buffer to find data that you specify. This is done with the **C-G** command. Let's see how this works. First, **PRESS: C-R** to position the screen to the beginning of the buffer. Now **PRESS: C-G**. The prompt Search: appears. **ENTER: Search** (capital S). The screen scrolls until the **C-G** keyboard function is positioned directly above the Search: prompt. Now **PRESS: (SPACE BAR)**, and the search will continue for the next occurrence of the word "Search." Since no other occurrences are present in the buffer, the search will scan to—and then stop at—line 1 of the buffer. To continue the search, **PRESS: (SPACE BAR)** again. Once again the program stops at "Search." You can either **PRESS: (RUN/STOP)** or **(RETURN)** to quit the search process. **PRESS: C<f1>** ten times to reposition the Keyboard Functions help screen.

Split-Screen Typing

The next command we will examine is the Split-Screen typing mode. **PRESS: C-J**. The two status lines have disappeared, and an underscore cursor is now displayed beneath the normal box cursor. Now **TYPE: The quick brown fox jumped over the lazy dog**. Your typing is displayed on the bottom two lines in the same color as the underscore cursor, rather than the normal character color. None of your characters have been sent to the modem yet. **PRESS: (RETURN)**. Now the complete line of text is sent to the modem, and—because we are in half-duplex—is displayed in the upper area. The bottom

area is now blank, with the underscore cursor again positioned under the box cursor. The split-screen mode is very useful for conferencing or other conversational situations. Your typing is not interspersed with received characters as can commonly occur in conferencing. **PRESS: (RUN/STOP)** to exit split-screen mode.

Printer Functions

The next set of functions to review are the printer functions. Make sure your printer is turned on before proceeding. Let's now look at the **C-Y** command (send disk file to printer).

PRESS: C-Y

The prompt line now shows: **ENTER FILE NAME: 0:comsen.hlp**

We can accept the filename listed (comsen.hlp) by pressing (RETURN) or we can enter a different name. We will use the default name for now: **PRESS: (RETURN)**. The file is read from disk and directed to the printer.

Now we'll print the information that is visible on the screen. **PRESS C-S** and the screen contents are directed to the printer.

We use **C-B** instead of **C-S** to print a larger area of the screen buffer. Try it now. **PRESS: C-B**. The prompt line asks us to what device we wish to output. **PRESS: P** to select the printer. Now the prompt line tells us to set the first line to print. (We use the scroll keys for this.) **PRESS: C-<f7>**, then **PRESS: (RETURN)**. Now we asked to set the last line. **PRESS: C-<f5>**, then **PRESS: (RETURN)**. The information we selected with the scroll keys is printed, and a new prompt appears: **CONTINUE?** For now, just **PRESS: N** to quit the buffer print. Note that the region selected by the scroll keys is marked by the line with the box cursor on it.

Another way to print a range is to use the bookmark function. **PRESS: <f7>** twice. Now **PRESS: C-H**. A prompt **SET OR FIND** is displayed. **PRESS: S** to set a bookmark at this point. Now **PRESS: <f5>** twice. **PRESS: C-B**, followed by **P**. Then **PRESS: B** (print from bookmark to here). This alternative makes unattended buffer dumps very easy to program, since you can set the bookmark at the beginning of an event, then print from that point to whatever line you currently reside. **PRESS: N** to quit the buffer dump.

The **C-O** functions, though primarily designed for modem communications, can be used very easily to move information around in your system. This capability is useful for translating files to/from PET

ASCII and standard ASCII, since the data will pass through the translation tables mechanism associated with the modem (remember to have the modem in half-duplex mode). In the following example, we will read a disk file, send it to the modem, and then print the data which is returned to the screen by the modem. Sound complicated? It really isn't.

PRESS: C-P (Toggle the printer)
PRESS: C-O
PRESS: 4 (to open the disk read channel)
ENTER: intro.scr

The disk file (intro.scr) is read and sent to the modem. Since we are in half-duplex mode, the information sent to the modem is redirected back to the screen and the printer. Note that the disk file channel is automatically closed when end-of-file is reached; the printer channel is still open, and will remain open until you close it with C-P.

Now let's repeat the process, but this time we'll convert the information to standard ASCII at the same time. **PRESS: C-E** to turn off the Transmit Translate.

PRESS: C-O
PRESS: 4
ENTER: intro.scr

Now look at the data being "received" and printed: it is in standard ASCII. Wait until the disk channel is closed, then **PRESS: C-E** to turn on Transmit Translate. To complete the process, **PRESS: C-P** to close the printer channel. The last line (or more if your printer is buffered) is printed, and the printer is closed.

Disk Functions

The one command we have not seen before is (CTRL)5. This is the File Copy (Disk) Utility. The purpose of this function is to copy disk files, with or without translation: it is extremely useful for converting ASCII files to PET ASCII in those cases where you receive an ASCII file in XMODEM when you expected PET ASCII. (See Reference section for a table of translation control when using this command.) The read and write channels are governed by the Set Channel command in the disk wedge. Set the Transmit and Receive Translation toggles as indicated in the Reference Section for the appropriate control. Then, **PRESS: (CTRL)5**. You will be prompted for the *write* file name first (this routine expects sequential files). Enter

the name of the file you want to create. Next you will be prompted for the read file name: enter the name of the file you are reading. When using this facility for copying program files, be certain to (1) turn OFF both translate toggles before starting, and (2) append ,p,w to the write file name and ,p,r to the read file name.

Screen Editor

Now let's switch to screen 2 where these commands are active: **PRESS: C-V**. Now **PRESS: C<f5>** followed by **C<f7>** to scroll the information from screen 1 to screen 2. **PRESS: C-E** to enter the editor mode. Notice that checkmarks (✓) appear wherever there are carriage returns so that you can see the length of each line. In addition to the standard Commodore editing keys listed, you can also use four special functions which are listed under the **C-E** description.

Let's try them. First, use the (CURSOR DOWN) key to position the cursor on the line below the (RUN/STOP) key description. **PRESS: (CTRL)D** to delete this blank line. Now **PRESS: (CTRL)I** to insert one line back again. Note that the ✓ is no longer on this line because we just inserted a blank line. **PRESS: (RETURN)** to place a checkmark on this line. Let's abort this editing: **PRESS: (RUN/STOP)** to return to screen 1 without saving our editing. Now **PRESS: C<f5>** to scroll the Screen Editor commands off screen 1. **PRESS: C-V** again. Our editing material is still on screen 2. **PRESS: C-E** to enter editor mode, then **PRESS: (CTRL)X** to save the material back on to screen 1. If you now **PRESS: C<f7>**, you will see that our original screen is still on screen 1, and that the new material has been placed into screen 1 exactly where we left the screen when we went to the editor. You can, in this way, build up larger texts than screen 2 can hold, and also edit large texts residing on screen 1.

Disk Wedge Commands

The Disk Wedge provides you with direct control of your disk drives. All valid disk commands can be performed, except Load and Save. The format of the commands is the same used with Commodore's DOS 5.1 Wedge, and are equivalent to the text following print # commands listed in the 1541 and 1571 Disk User Manuals (without the quotation marks).

To begin the disk wedge commands, **PRESS: C-W**.

Now enter any of the following disk wedge commands.

Pressing (RETURN) will exit you back to terminal mode.

COPY: create a duplicate copy of a disk file.

format: **c** <drive #>:<new filename> = <drive#>:<old filename>

Example: make a copy of a file called "tic-tac-toe" on drive 0, naming the new file "t-t-t."

c0:t-t-t = tic-tac-toe

DIRECTORY: list the contents of the disk directory.

format: **\$**<drive#>[:<optional filename>]

Example: list the contents of drive 0.

\$0

DUPLICATE: create a duplicate (backup) of an entire disk. Requires a dual drive unit.

format: **d**<destination drive#> = <source drive#>

Example: backup the disk in drive 1—new disk in drive 0.

d0 = 1

Note: put a write-protect tab on the source disk to prevent accidental erasure. The destination disk is first reformatted so that any data on it is lost.

INITIALIZE: force the disk unit to read the directory header on the disk.

format: **i**<drive#>

Example: initialize drive 0.

i0

NEW: format a new disk, or reformat an old disk. This destroys the contents of the disk, effectively wiping it clean.

format: **n**<drive#>:<disk name>,<id>

Example: format a disk with the name "my disk" and an id of "01"

n0:my disk,01

RENAME: change the name of a file
format: r<drive#>:<new name> = <old name>

Example: change file "abc" on drive 1 to "def"

r1:def = abc

RESET: return disk unit to power-up status.
format: uj (4040s, MSDs, new 1541s, 1571s)
U; (old 1541s)

SCRATCH: erase (delete) a file from the disk directory.
format: s<drive#>:<filename>[,<drive#>:<filename>...]

Example: delete 3 files from drive 1 called "abc," "def," and "ghi."

s1:abc,1:def,1:ghi

VALIDATE: check the allocated blocks on a disk. Use this command to recover space from an improperly closed file (indicated by an asterisk (*) next to the file type when you list a directory).
format: v<drive#>

Example: validate the disk in drive 0.

v0

SET READ OR WRITE CHANNEL: set the device and drive number used by the program.

format: /<direction><device# minus 8><drive#>

Example: set read channel to device 8, drive 0

/r00

Example: set write channel to device 10, drive 1

/w21

Note: (RETURN) is not required with the SET command. Do the command over again if you make a typing error.

Autodial Functions (Direct-connect Modems)

The simplest form of dialing is to **PRESS: ⌘A**, then enter the number to dial. You can include commas to cause 1-second delays in the dialing procedure, and you can also type in text along with the number to be dialed.

(CTRL)D selects touch-tone dialing, and (CTRL)P selects pulse (rotary) dialing. Use (CTRL)S to set a slow pulse rate of 10 pulses per second.

The following words are automatically printed to the screen for information:

RING	indicates that someone is calling you.
CONNECT	dialing sequence successful.
NO CARRIER	wait time exceeded without a connect.

The (CTRL)R command re-dials the last number without having to re-enter the number.

(CTRL)A will “pick up” the line to answer a call. No check for carrier detect is made: carrier is assumed to be present. Use the wait command (CTRL)Wnn following the (CTRL)A if you need to test for carrier.

(CTRL)H will “hang up” the line. Use this for immediate disconnect.

NOTE: These commands must be followed by a (RETURN) to begin operation.

Screen Control Functions

⌘C is used to change the screen colors. Try it now. **PRESS: ⌘C**. You can change any of the five colors used (text1, text2, border, screen, and cursor) by pressing the appropriate underlined letter in this list. Continue to press the key until the color you want appears. After you have set the colors to your liking, **PRESS: (RETURN)**. Notice that you cannot set the screen and text colors to the same color.

FIGURE 4-3
SCREEN COLORS

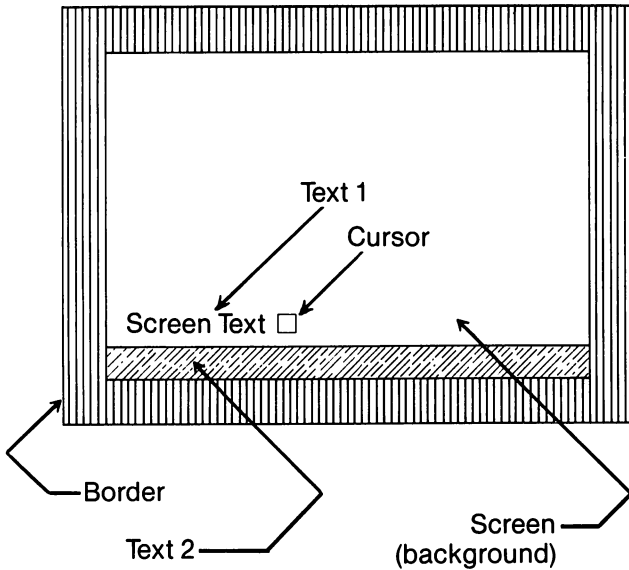

Colors:

- | | |
|---------|-------------|
| Black | Orange |
| White | Brown |
| Red | Light Red |
| Cyan | Dark Gray |
| Magenta | Medium Gray |
| Green | Light Green |
| Blue | Light Blue |
| Yellow | Light Gray |

NOTE: The program will prevent you from setting any combination of colors that would hide data. (Like white text on a white background.)

File Transfer Protocols

File Transfer Protocols are used, as the name implies, to transfer files of information from one computer to another under control of a predetermined, formal communications sequence (protocol). This varies considerably from the simple transmission of text. Protocols are designed to ensure that the information is transferred without

error. **COMMON SENSE** includes two such protocols: CompuServe "B" and XMODEM.

CompuServe "B" Protocol is a proprietary file transfer protocol of CompuServe, Inc. which is used to send and receive files between your Commodore computer and CompuServe. It is a totally automatic process; once you indicate that you wish to send/receive using "B," the two computers will handle all communications without your intervention. The top status line will indicate the current status of the transfer as it occurs. Please note that the B Protocol Inhibit must be off: the "B" must be showing on the bottom status line for the process to work. Also note that if the transfer is aborted for any reason, **COMMON SENSE** will automatically turn on the Inhibit: you must turn it off again yourself.

XMODEM is a file transfer protocol used between many different kinds of computers, and is a semi-automatic process. When communicating with host computers, such as BBS's or mainframe services, the host will normally tell you when you should begin the XMODEM protocol. When talking with other personal computer users, you should first agree to begin the process before doing so. You begin XMODEM by pressing **C**X and then answering the questions prompted. Use (RUN/STOP) to abort a transfer; otherwise the process will continue until completed. Translation control is active during XMODEM sequential file transfers. The normal situation is that the Transmit and Receive Toggles are "on" and data sent or received is translated from/to PET ASCII and standard ASCII. Use these settings when transferring sequential (text) files to non-Commodore computers. Turn off Transmit Translate when uploading (sending) to a Commodore system; turn off Receive Translate when downloading (receiving) from a Commodore system.

REFERENCE

Command Index

Command	Name	Page	Command	Name	Page
C A	Automodem	36	C O	Printer	40
C B	Screen Dump	37	C P	Printer Toggle	41
C C	Colors	37	C Q	Quit	41
C D	Delay Factor	37	C R	Return to Top of screen	41
C E	Edit	38	C S	Print Visible Screen	41
C F	Display Disk File	38			

Command	Name	Page	Command	Name	Page
C G	Search Screen	39	C T	Clock	41
C H	Bookmark	39	C U	Delay Factor	41
C I	Inhibit	39		Toggle	
	B Protocol		C V	Switch Screens	41
C J	Split-Screen	39	C W	Disk Wedge	42
	Mode		C X	Xmodem	42
C K	Function keys	39	C Y	Print Disk File	42
C L	Linefeed	40	C Z	Clear Screen	43
	Toggle			Buffer	
C M	Modem Setting	40	C @	Clear Visible	43
			C £	Transmit	43
				Translate	
C <f1>	Scroll up	43	(CTRL)5	File copy utility	43
	one line		(SHIFT)(†)	Shift lock	44
C <f3>	Scroll down	43	(SHIFT)£	Receive	
	one line			Translate	44
C <f5>	Scroll up	43			
	one page				
C <f7>	Scroll down	43			
	one page				

Command Reference

Keys	Name	Purpose
C A	Autodial	Provide phone dialing functions.
	Functions:	(CTRL) A—Pick up phone line (ANSWER) (RETURN)
		(CTRL) D—Dial using touch tones
		(CTRL) P—Dial using pulse (rotary) tones
		(CTRL) H—Hang up phone line (RETURN)
		(CTRL) S—Set 10 pulse per second rate (normal)
		(CTRL) F—Set 20 pulse per second rate (fast)
		(CTRL) R—Repeat last C A command (REDIAL)
		<phone #>—Number to dial
		<comma>—Delay one second per comma
		(RUNSTOP)—Abort data entry
		(RETURN)—Execute command
		(RUNSTOP) Abort dialing in progress

Keys	Name	Purpose
C-B	Screen 1 Data Dump	Transfer text from the virtual screen to Disk, Printer or Modem. (Buffer Dump)
	Functions:	<p>D—Dump range of data to Disk File ENTER: <filename> [See: SET RANGE below]</p> <p>P—Dump range of data to Printer [See: SET RANGE below]</p> <p>M—Dump range of data to Modem (Upload text) [See: SET RANGE below]</p> <p>SET RANGE: (B selects bookmark position) <SCROLL> (RETURN) or PRESS: B Set top of range <SCROLL> (RETURN) or PRESS: B Set bottom of range and begin dump.</p> <p>(RUNSTOP) Abort dump <Y><N> Continue with new range?</p>
C-C	Color Control	Set Text, Screen, Border and Cursor Colors
	Functions:	<p>1—Set Screen 1 text color 2—Set Screen 2 text color S—Set background color screens 1 & 2 B—Set border color C—Set cursor color (RUNSTOP)—Leave function (RETURN)—Leave function</p>
C-D	Set Delay Factor	Set inter-character delay from zero to 255 milliseconds and/or delay after carriage return from zero to 255 seconds. Should only be used to slow down uploads from disk or screen 1 (buffer) when remote host is unable to handle full speed transfer.

Keys	Name	Purpose
	Functions:	<p>ENTER: # # #</p> <p>Will set delay factor for currently active (displayed) delay function. If 'D' then inter-character delay set. If '↵' then delay after carriage return is set.</p> <p>SEE ALSO: C-U</p>
C-E	Edit Mode	<p>Provides a screen editor for editing screen 1 text as well as composing textual data for uploading from screen 1 or disk file.</p> <p>Functions:</p> <p>(RUNSTOP)—Abort editor (CTRL) D—Delete line (CTRL) I—Insert line (CTRL) X—Transfer edit to screen 1 (CRSR) (up)—Move cursor up 1 line (CRSR) (down)—Move cursor down 1 line (CRSR) (right)—Move cursor right 1 space (CRSR) (left)—Move cursor left 1 space (CLR/HOME)—Move cursor to HOME position (SHIFT) (CLR/HOME)—Clear screen (INST/DEL)—Delete 1 character (SHIFT) (INST/DEL)—Insert 1 space (RETURN)—Place checkmark and go to next line</p> <p>[macro keys]—Active during edit. Only the above-listed functions are valid. After a (CTRL)X other commands may be included in the macro key</p>
C-F	Show Disk File	<p>Transfer text file on disk to Screen</p> <p>Functions:</p> <p>ENTER: <filename>—Name of file to show on screen. (RUNSTOP)—Abort function.</p>

Keys	Name	Purpose
C-G	Search Screen 1	Search for occurrences of user specified string on virtual screen (Buffer search). Functions: ENTER: <string>—Text to search for (RUNSTOP)—Abort data entry or search. (SPACEBAR)—Find next occurrence of string or continue search if stop at Line 001.
C-H	Hold Place Screen 1	Save current virtual screen line position to memory or reset to last position saved. This is the 'bookmark' command that will allow you to instantly recall a memorized position within the 700 line virtual screen (buffer) Functions: S—Set the current line as the memory point. F—Find the memorized line. (RUNSTOP)—Abort the function.
C-I	Inhibit B Protocol	Inhibit or allow B Protocol processing. Functions: NONE Display: Letter 'B' Line 2 position 26 of System Status when B protocol allowed.
C-J	Split Screen Mode	Allow simultaneous split screen operation with real time received data displayed on lines 1 thru 23 and user key input to lines 24 and 25. The data keyed by the user will be transmitted when the user types a RETURN. Functions: ENTER: <string>—Data to be transmitted. (RUNSTOP)—Abort Split screen mode
C-K	Function Keys	Load, Save, Display and Define the Function Keys

Keys	Name	Purpose
	Functions:	<p>(RUNSTOP)—Abort function</p> <p>L—Load a block of 16 Function Key definitions from disk.</p> <p>ENTER: <filename>—Name of function definition disk file.</p> <p>(RUNSTOP)—Abort filename entry.</p> <p>S—Save the current definitions to a disk file.</p> <p>ENTER: <filename>—Name of function definition disk file.</p> <p>(RUNSTOP)—Abort filename entry.</p> <p>D—Display current Function Key definitions.</p> <p><key>—Define selected Function Key. (80 keystrokes max.)</p> <p><string>—Function Key data.</p> <p>(CTRL) 0—Function Key Security</p> <p>(SHIFT)@—End Function Key Define</p>
C-L	Linefeeds	Toggle linefeed after carriage return sent to remote computer.
	Functions:	NONE
C-M	Modem Functions	Permit user adjustment of modem transmission characteristics.
	Functions:	<p>(CRSR) (right)—Select modem parameter.</p> <p>(CRSR) (down)—Adjust selected parameter.</p> <p>(RETURN)—End function.</p> <p>(RUNSTOP)—End function.</p>
C-O	Disk I/O	Toggle open status of disk channel
	Functions:	<p>1—Open disk write channel if closed. ENTER: <filename></p> <p>2—Suspend disk write channel if open.</p> <p>3—Close disk write channel.</p> <p>4—Open disk read channel if closed. ENTER: <filename></p>

Keys	Name	Purpose
		5—Suspend disk read channel if open. 6—Close disk read channel.
C-P	Printer I/O	Toggle printer on and off.
C-Q	Quit Program	Exit program to Basic.
	Functions:	Y—Exit N—Return to program.
C-R	Reset To Line 001	Quick access to start of virtual screen.
	Functions:	NONE
C-S	Screen Print	Dump the current screen to the printer.
	Functions:	NONE
C-T	Clock Functions	Clock functions.
	Functions:	Set the 24 hour system clock. TYPE: <hh><mm> Hours & minutes (RUNSTOP)—Abort clock function
C-U	Delay After Return	Toggle delay after (RETURN)
	Functions:	NONE
C-V	Switch Screens	Toggle between Screen 1 (700 line virtual screen and Screen 2 the normal 25 line screen.
	Functions:	NONE

Keys	Name	Purpose															
C-W	Disk Wedge	Provide access to disk for user maintenance while 'on-line'.															
	Functions:	<ul style="list-style-type: none"> \$—Disk Directory I—Initialize drive N—New diskette R—Rename Disk file S—Scratch disk file V—Validate disk C—Copy disk file D—Duplicate disk /—Set active disk devices /(<u>d</u>)(<u>dev</u>)(<u>drv</u>) <table style="margin-left: 100px; border: none;"> <thead> <tr> <th><u>d</u></th> <th><u>dev</u></th> <th><u>drv</u></th> </tr> </thead> <tbody> <tr> <td>r = read</td> <td>0 = 8</td> <td>0 = 0</td> </tr> <tr> <td>w = write</td> <td>1 = 9</td> <td>1 = 1</td> </tr> <tr> <td></td> <td>2 = 10</td> <td></td> </tr> <tr> <td></td> <td>3 = 11</td> <td></td> </tr> </tbody> </table>	<u>d</u>	<u>dev</u>	<u>drv</u>	r = read	0 = 8	0 = 0	w = write	1 = 9	1 = 1		2 = 10			3 = 11	
<u>d</u>	<u>dev</u>	<u>drv</u>															
r = read	0 = 8	0 = 0															
w = write	1 = 9	1 = 1															
	2 = 10																
	3 = 11																
C-X	XMODEM Transfer	Transfer disk files via XMODEM protocol															
	Functions:	<ul style="list-style-type: none"> S—Send file to remote system from disk R—Receive file to disk from remote system S—Sequential file type P—Program file type (RUNSTOP)—Abort XMODEM ENTER: <filename>—File to send or receive <p>Turn OFF Translate toggles <i>first</i> to send or receive sequential files without translation.</p> <p>XMODEM transfer of sequential files will use the current state of the translation functions (C-£ and (SHIFT) £).</p>															
C-Y	Disk File To Printer	Print desired disk file.															
	Functions:	<ul style="list-style-type: none"> ENTER: <filename>—File to print (RUNSTOP)—Abort function 															

Keys	Name	Purpose
C-Z	Zero Screen 1	Erase ALL 700 lines of virtual screen
	Functions:	Y—Erase the screen. N—DO NOT erase the screen (RUNSTOP)—Abort the function.
C@	Clear Screen	Erase just the current screen. 23 lines and the matching buffer or 25 lines on screen 2.
	Functions:	NONE
C£	Transmit Table	Allow transmission of either PET ASCII or standard ASCII codes by toggling transmit table look-up on and off.
	Functions:	NONE
Cf1	Scroll Up 1 Line	
Cf3	Scroll Down 1 Line	
Cf5	Scroll Up 1 Page	
Cf7	Scroll Down 1 Page	Provide access to 700 line virtual screen
	Functions:	NONE
(CTRL)5	File Copy Utility	Provide direct file copy between any disk units. File may be translated to/from PET ASCII and Standard ASCII.
	Functions:	ENTER: WRITE FILE NAME ENTER: READ FILE NAME
		Drive numbers set in filename entry. Device number controlled by CW/ .

Translation Control: Status Settings

(R) (T)

PET to PET	OFF	OFF
PET to ASCII	OFF	ON
ASCII to PET	ON	OFF
ASCII to ASCII (transparent)	OFF	OFF
ASCII to ASCII (filtered)	ON	ON
PROGRAM to PROGRAM	OFF	OFF
(,p,r) (,p,w)		

Keys	Name	Purpose
	Warning:	Translate tables ON during Program to Program transfers will cause undesirable results.
	Note:	You can convert file types (e.g., program to sequential) by appropriate filename specification.
(SHIFT)(↑)	Caps Lock	Provide caps lock for alpha keys only.
	Functions:	NONE
(SHIFT)(£)	Receive Translate	Permits turning receive translation (ASCII to PET ASCII) on and off. This allows direct reception of PET ASCII codes from the remote system.
	Functions:	NONE

Using the CHANGE.MTS Program

Purpose:

Alter the ASCII translation tables used by the Transmit and Receive toggles.

You can adjust the translation tables to generate any single-character value desired. The most common use of SS.CHANGE is to alter the action of the DELETE key: the table as supplied converts the PET ASCII Delete to a true ASCII Delete (decimal 127, hex \$7F) which is the value used by Digital VAX systems and many mainframes. Many systems, however, use the ASCII Backspace (decimal 8, hex \$08) as the delete character: this is particularly true of BBS systems and CompuServe. The example used in this section shows how to change the Delete character to a backspace.

- (1) ENTER: **LOAD"CHANGE.MTS",8 (in 64 mode)**
- (2) ENTER: **RUN**
- (3) Insert the disk containing the translate table you wish to change.
- (4) **PRESS: (RETURN)**
The program will take a few seconds to read the translate table.

(5) Select Transmit. TYPE: **t**

(6) Select code to view/change.

The program expects the **decimal** value equivalent of the key-stroke you are viewing/changing. Use the ASCII chart in your computer's User Guide.

ENTER: **20**

The program will display **127** (true ASCII Delete).

(7) Indicate whether you wish to save or change.

TYPE: **c**

(8) Enter the new decimal code.

ENTER: **8**

(9) Select Receive. TYPE: **r**

(10) Select code to view/change.

The program expects the decimal value equivalent of the received character you are viewing/changing. Use a standard ASCII chart.

ENTER: **8**

The program will display **0** (null character).

(11) Indicate whether you wish to save or change.

TYPE: **c**

(12) Enter the new decimal code.

ENTER: **20**

(13) Save your new table values.

PRESS: **<f1>**

(14) Remove the disk from the drive.

SETTING UP MULTIPLE DRIVES

(1) Review format for Set Channel (active disk devices) under the **C-W** command in the Reference Section.

(2) PRESS: **C-W**

- (3) TYPE the Set Read Channel as **/r<device><drive>**
Example: Device 8, Drive 0 /r00
- (4) TYPE the Set Write Channel as **/w<device><drive>**
Example: Device 9, Drive 1 /w11
- (5) PRESS: <RETURN>

Section 5 Using the VT100-128 Terminal Emulator

WHAT IS A TERMINAL EMULATOR?

Many large computers, as well as some information services, recognize special escape sequences to cursor-up, cursor-down, clear the screen and perform other screen editing functions. These escape sequences allow the computer to display the screen much faster than if every space and character had to be printed, and scrolling occurred line by line. Ordinarily during telecommunication your computer acts as a “dumb terminal”, an input/output device for data. With a special program called a terminal emulator, your computer can become an “intelligent” terminal, and perform escape functions such as those listed above.

How Terminal Emulators Are Used

Terminal emulator programs replace other terminal programs such as Common Sense for use with your modem.

The VT100 Terminal Emulator program works only in the 80-column mode of the C128. A 1902 monitor is required.

You must inform the host computer that you will be using a terminal emulator. Each mainframe or information service that recognizes terminal emulators has a set of preliminary instructions that declares the use of a VT100 terminal emulator. Refer to the para-

graphs entitled "Declaring the Terminal Emulator" for specific instructions for the computer you are contacting.

VT100-128:

Insert your program disk into the drive. To load and run the program, type:

RUN"VT100-128"

Uploading and downloading are supported with either a simple buffer or with the XMODEM protocol. Printer support is also included to allow you to log your terminal session to a printer. The HELP key allows you to view disk-based help files.

Using the Features of VT100

The features of the VT100-128 program are accessed by using the [ALT] key. The [ALT] key is located in the upper left hand corner of the C128 keyboard between the TAB and the CAPS LOCK keys.

You hold down the [ALT] key, while pressing another key.

A summary of the [ALT] (and other) key functions follows, but first, let's discuss the display. At the top of the display is a STATUS LINE. On the right hand side of the status line is a real time clock. (You may set the clock with [ALT] J). On the left hand side of the status line is a large number representing the number of bytes left in the buffer. Between the buffer size and real time clock are various indicators and prompt messages. Here is a list of single letter indicators:

Letter	Indicates
T	XMODEM transfer ([ALT] X)
B	Buffer is active ([ALT] B) (exit with another [ALT] B)
L	Line feed is generated ([ALT] L) (exit with another [ALT] L)
X	Transmission stopped with <HOME> key (exit with <CRSR DOWN> key)
S	Line entry mode ([ALT] H) (exit with <STOP> key)

This key allows you to dump the contents of the buffer to the disk, to the printer, to the screen, or to the trash can. When prompted on the status line, press the first letter of the device you wish to dump to.

- D Dump to Disk—then press S or P for Sequential or Program file. Then enter the filename, press return and the buffer will be stored to disk. Now press Y or N to clear the buffer or not.
- P Dump to Printer—press Y or N to remove Line feeds or not. (Most printers already have this done, so Y is a good choice if you are not sure.) Now press Y or N to clear the buffer or not.
- S Dump to Screen—press NO SCROLL to pause or resume printing. Now press Y or N to clear the buffer or not.
- M Dump to Modem—will send the buffer contents back to the host computer. Hit <RUN-STOP> to abort.
- C Clear the Buffer—will discard the entire buffer contents.

[ALT] DEL Toggle the Delete Key

This key will change the value of the delete key between 8 (backspace) 127 (DEL), and backspace with erase.

[ALT] E Erase (clear) the screen

[ALT] F Load a disk file into the buffer

This command will let you fill your buffer with a file from the disk. Press S or P for a sequential or program file load. Then enter the file name. In order to see the file, type [ALT] D and then S for a Dump to Screen. The [ALT] D key can also dump to the printer or to the modem.

[ALT] H Enter Split Screen (Line Entry) Mode

A “S” is displayed in the status line to indicate that you are in the split screen mode. In this mode, the text that you type in is not transmitted until you press <return>. This is most useful in an on-

line conference, so that what you type is not mixed in with the other information on the screen. Your text is displayed in a different color at the bottom of the screen. To exit this mode, press <RUN-STOP>.

[ALT] J Set the Clock

Enter the new time in the form of HHMM. No return is necessary. The computer will automatically put in the colon between the hours and minutes.

[ALT] K Function Keys

This key will allow you to set up function key definitions for commonly used commands. You may define each of the eight function keys to be items such as your User ID, or Password. Press number 1 through 8 to choose which function key to define. Press <return> if you want the command to be executed. End the function key definition with the <RUN-STOP> key. [ALT] K will also let you load and save function key definitions by pressing L or S, and typing the filename as prompted. You may also view the function key definitions by pressing V in the [ALT] K menu.

[ALT] L Toggle Line Feeds

This key will toggle Line feeds ON or OFF. For <return> only, leave this toggled OFF. If the host computer requires <return> and <line-feed> then toggle this ON. An "L" will be visible on the status line when line feeds are ON.

[ALT] M View/Change Modem Settings

This command will allow you to change between half or full duplex, change the number of stop bits between 1 and 2, change the word length to 7 or 8 bits, and change the parity to Even, Odd, Mark, Space, or None. This is all done with the <CRSR UP/DOWN> key.

Every combination of baud, duplex, stop bits, word length, and parity are displayed on a rolling basis. Simply press <CRSR UP/DOWN>

to go to the next possible combination. The possible combinations are:

1200:F:1S:8W:N**	1200:H:1S:8W:N
1200:F:1S:7W:E**	1200:H:1S:7W:E
1200:F:1S:7W:O	1200:H:1S:7W:O
1200:F:1S:7W:M	1200:H:1S:7W:M
1200:F:1S:7W:S	1200:H:1S:7W:S
1200:F:2S:7W:N	1200:H:2S:7W:N
0300:F:1S:8W:N**	0300:H:1S:8W:N
0300:F:1S:7W:E**	0300:H:1S:7W:E
0300:F:1S:7W:O	0300:H:1S:7W:O
0300:F:1S:7W:M	0300:H:1S:7W:M
0300:F:1S:7W:S	0300:H:1S:7W:S
0300:F:2S:7W:N	0300:H:1S:7W:N

** MOST COMMON

Note that the 1660 is a 300 baud modem, so only those combinations indicating 300 baud will operate correctly. After everything is set, press <RUN-STOP> to exit.

[ALT] N Load new Options File

This key will load the file "OPTSET" from disk that contains information about the default screen colors, the drive device number, the type of modem being used, the printer secondary address, the printer hold off guard time for printing on the fly, uploading prompt, and CTRL E response. These settings can be changed with the **C=O** command.

[ALT] O Save current Options File

This is the opposite of [ALT] N. These settings can be changed with the **C=O** command.

C=O View/Change Options

With this function, you can customize the program to your particular needs/tastes. You can change the default colors of the characters, background, top status line, and bottom split screen line by entering the number of the color as prompted. DO NOT use the <return> key to enter numbers, instead, use the <enter> key on the numeric key pad to enter the value.

The numbers for each color are:

0 = black	8 = orange
1 = white	9 = brown
2 = red	10 = lt. red
3 = cyan	11 = dk. grey
4 = purple	12 = med. grey
5 = green	13 = lt. green
6 = blue	14 = lt. blue
7 = yellow	15 = lt. grey

In the same manner, you can change the default disk device number. Most people will want to leave this at 8. You can also use this with many different kinds of modems. Enter the number according to the modem that you are using:

0 = VIC Modem	(1600) and dumb modems
1 = Auto Modem	(1650) and compatibles
2 = Modem/300	(1660) with carrier detect
3 = Modem/300	(1660) without carrier detect
4 = Modem/1200	(1670) and other 1200 baud smart modems

You can also change the printer secondary address. Normally this is set to 7 to force lower case printing. The hold off guard time is also programmable. This allows the printer more time after each return before feeding more data to it. If your printouts start dropping characters, try increasing this number. This number is calibrated in 1/60ths of a second.

Also programmable is the uploading prompt. This is the character which prompts the C128 to send the next line during an upload. The default on this is a <return>. It is denoted by a checkmark symbol. To enter a <return> in this blank, press the <enter> key to advance to the "Prompt: ", then press <return>, followed by an <enter>.

Some services will send a CTRL E and expect the terminal to respond in an appropriate fashion. You may enter this as the last item in this menu. Again, you must use the <enter> key to terminate your response. Then press <RUN-STOP> to exit. If you would like to save these options, press [ALT] O. Everytime you use the program from this time forward, you will automatically have these options set.

[ALT] P Toggle Printer

This key will allow you to print everything as you are receiving it “on-the-fly”. This will slow down the output considerably, and you may wish to open the buffer ([ALT] B), to capture the data in real time, then log off, and dump the buffer to the printer ([ALT] D P) instead to save you money and connect time. But if the amount of information is small, this might be more useful. The status line indicates “P” when the printer is active. Press [ALT] P again to de-activate the printer.

[ALT] Q Turn ON auto key repeat

This key turns on auto key repeat: if you hold down a key it will repeat until you release the key.

[ALT] R Turn OFF auto repeat

[ALT] S Screen dump to Printer

[ALT] T Transfer from Disk

This key allows you to transfer a sequential file from disk to either the screen, or the printer without using the buffer. Simply enter S or P for Screen or Printer, then enter the file name and press return. Press any key to exit.

[ALT] U ASCII Upload Disk File

This key allow you to do a straight ASCII upload of text information without error checking or correcting. First, you will need to open a file for writing on the host. Then type [ALT] U. The program will prompt you for the filename you wish to upload. Enter the name and press <return>. At the end of the upload, you will need to close the file on the host.

[ALT] V Toggle Normal/Reverse Video

[ALT] W Enter Disk Command Mode (Wedge)

The same wedge commands that are used by Common Sense are supported. See Section 4 of this manual for details.

[ALT] X Enter the XMODEM file transfer mode

In order to transfer a file or program using the XMODEM protocol, first tell the host computer which program you would like to upload or download. Then press [ALT] X, and enter the filename as follows:

<filename>,<type>,<direction>,<translate>

where <filename> is the file on/for your disk.

<type> is "p" for a program file, or
"s" for a sequential file,

<direction> is "r" if sending (disk read)
"w" if receiving (disk write)

<translate> is "t" if you want data translated from PETSCII to
ASCII and vice versa, (sequential text files only),
otherwise enter nothing.

The program will perform the transfer automatically, and show the status on the status line. BLK = the number of blocks sent or received, CHK = A for a good block, or N if a retry is required. If there are any errors due to noisy phone lines, etc., the protocol will re-transmit that block until it is received correctly.

[ALT] Z Exit to BASIC

[ALT] UP-ARROW Recover a Cleared Buffer

If you accidentally cleared the buffer, this key will let you recover it. Simply press Y or N to confirm your request.

[ALT] BACK-ARROW Create a backup disk

This will allow you to save the program, and create the ASCII translation and TELSET display character files. Save the OPTSET file separately with the [ALT] O command. The help files (VT100?.HLP) are not moved, but this can easily be done with the [ALT] F, to load the file into the buffer, and the [ALT] D, to dump to disk.

[ALT] * Modify ASCII tables

You can modify the ASCII translation tables with this command. Under normal circumstances, this is not necessary. You can change the receive or the transmit tables, or both. Press R or T for receive or transmit. Now press the key that you wish to change, next the key you wish to change it to. When you are all done, press <RUN-STOP>. The program will ask you if you want to save these new changes. Press Y or N.

LINEFEED Send a BREAK signal

The LINEFEED key is located next to the HELP key.

CURSOR KEYS

The CRSR UP/DOWN and CRSR RIGHT/LEFT keys on the main

keyboard generate C128 local cursor values. Note that the four arrow cursor keys along the top of the keyboard generate the VT100 escape codes for the appropriate cursor movement.

KEYPAD

The 18 keys of the keypad (including the Function Keys) will generate the VT100 escape sequences ONLY if the [ALT] key is pushed (including the PF1, PF2, PF3, and PF4 keys). Normally the keypad generates the same codes as the numeric counter parts above the keyboard. The function keys are normally the function keys as programmed with the [ALT] K key. Some hosts may send an escape code to reverse this process. In these cases, you may not need to press the [ALT] key for VT100 escape sequences; pressing the [ALT] key will generate numbers instead.

SEVEN EXTRA KEYS

There are seven characters not implemented on a C128 that are necessary for a VT100. They have been assigned as follows:

{	(left curly brace)	shift +
}	(right curly brace)	shift -
	(vertical bar)	⌘ -
~	(tilde)	shift up-arrow
^	(carat)	up-arrow
\	(backslash)	British Pound
`	(grave accent)	shift @

Declaring the VT100 Terminal Program

VAX UNIX users should be able to set their "termcap" to vt100 for programs such as vi, emacs, etc. For example:

```
setenv TERM tset vt100
```

VAX VMS users, in order to use editors like "edt" will want to type:

```
set term /dev = vt100
```

TOPS-20 users can use:

```
term vt100
```

CompuServe users will want to type:

```
go default      (that's right—spell it incorrectly!)
2               (select "Setting Your Terminal Type")
2               (select "ANSI/VT100")
```

If you have difficulties with setting the terminal type, you may have to consult a person at the host computer you are trying to connect with.

Section Technical Information

The following information is provided for programmers and advanced users who require more specific information about the Modem/300.

Data Format: binary, serial, asynchronous, 10 bits

Operational Modes: auto answer, auto dial
manual switch selected originate/answer mode

Data Rate: 0 to 300 baud (bps)

Modulation/demodulation: Frequency shift keying (standard Bell 103)

Line Interface: Direct Connect, FCC part 68 approved (USA),
DOC approved (Canada)

Modem's Modular Telephone Jacks: both are USOC RJ11C

Data Interface: Commodore User Port (inverted TTL RS232)

Carrier Indicator: high frequency tone
(built-in piezo electric speaker)

Dialing Method: Touch Tone (DTMF) or Rotary (pulse)

DC Specifications

Supply voltage (VCC) 4.5 to 5.5 v < 25mA

Supply voltage (9VAC) 12Vpp on 6Vdc +/- 30% @ 40mA

Minimum high level input voltage 3.15V

Maximum low level input voltage 1.1V

Minimum high level output voltage VCC -.1V @ 20uA
Maximum low level output voltage .1v @ 20uA
Mark = High
Space = Low

AC Specifications

Modem Frequencies

Originate:

Transmit: Space = 1070Hz, Mark = 1270Hz

Receive: Space = 2025Hz, Mark = 2225Hz

Answer:

Transmit: Space = 2025Hz, Mark = 2225Hz

Receive: Space = 1070Hz, Mark = 1270Hz

Maximum frequency error: 4Hz
Maximum output power: -9 dBm
Minimum output power: -15 dBm
Carrier detect threshold: -44 dBm on/ -47 dBm off
Maximum audio input voltage: 2.6V ACpp
Maximum frequency error: 1%
Maximum output power (DTMF pair): + 1 dBm
Maximum output power (either tone): 0 dBm
Minimum output power (low group): -8.5 dBm
Minimum output power (high group): -6.5 dBm
Touch Tone dialing rate: 100 ms on/100 ms off
Rotary dialing rate: 40 ms make/ 60 ms break

Environment

Operating Temperature: 0 to 50°C
Storage Temperature: -20 to 70°C
Humidity: 20 to 95% RH (non-condensing)

User Port Pin Connections

PIN	FUNCTION	SOURCE
1,12,A,N	Ground	from computer
2	Vcc(+5)	from computer
10	9VAC	from computer
B,C	RxD	from modem
M	TxD	from computer
J	/OH	from computer
F	/RI	from modem
H,K	DCD,CTS	from modem
L	DSR	ground
E	DTR	not connected

Section Troubleshooting

This section describes some of the common problems you may encounter using the Modem/300, and tells what to do to fix them.

CONNECTION PROBLEMS

- 1) "I followed the connection instructions, but when I turned the computer on the modem started buzzing!"

You may have installed the modem incorrectly, or with the computer turned on. Turn off the equipment, install the modem again, then turn on the computer, disk drive and monitor. Be sure not to unplug the modem once the computer is turned on. Also, be sure you have connected the audio cable correctly.

- 2) "When I plugged the cord into the LINE jack on the modem, the phone gave a short ring. Is something wrong?"

It's okay for the phone to give one quick ring. If the modem buzzes, however, turn off your computer, check all cables and connections and try again.

TERMINAL MODE PROBLEMS

- 1) All I get on the screen is garbled characters!

If you are **not on-line**, this is probably a connection problem. See question 2 under **Connection Problems**.

If you are on-line, there could be two reasons:

- a) You are using incorrect telecommunications parameters for the particular host you are calling.

b) A noisy or "hot" telephone line

Solution to a) Alter the parameters according to the directions provided by Common Sense or any other terminal program you are using, and try to retransmit.

Solution to b) A noisy telephone line can occur when telephone lines get overloaded. Stop transmitting and redial to try to get a better connection. If the trouble persists, contact your telephone company.

2) "Voices are coming over my modem!"

You probably dialed the wrong number. Hang up and try again.

CUSTOMER SUPPORT

If you have tried all the suggestions above, and your Modem/300 still won't function, contact Commodore Customer Service:

1200 Wilson Drive
West Chester, PA 19380
(215) 436-4200

Commodore representatives are on hand to help you find and correct any problem. You can call between 9 a.m. and 8 p.m., Monday through Friday.

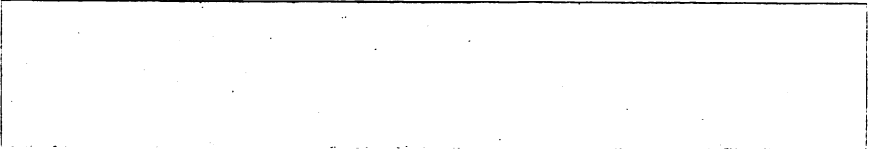

Appendix: Advanced Basic Programming Techniques With Your Modem/300

The following information tells you how to:

- 1) Generate Touch Tone frequencies
- 2) Detect telephone ringing
- 3) Program the telephone to be on or off the hook
- 4) Detect carrier

with your Commodore 128,64, SX-64 and VIC 20 computer.

GENERATING TOUCH TONE (DTMF) FREQUENCIES

Each button on the face of your touch tone telephone generates a different pair of tones (frequencies). You can simulate these tones with your Commodore 128, and 64 computer. Each button has a row and column value in which you must store the appropriate memory location in order to output the correct frequency. Here are the row and column frequency values that apply to each button on the face of your touch tone telephone:

<u>Column 1 (1029 Hz)</u>	<u>Column 2 (1336 Hz)</u>	<u>Column 3 (1477 Hz)</u>
Row 1 (697 Hz) 1	2	3
Row 2 (770 Hz) 4	5	6
Row 3 (852 Hz) 7	8	9
Row 4 (941 Hz) *	0	#

To generate these tones in BASIC with your Commodore 64 or Commodore 128:

- 1) Initialize the sound (SID) chip with the following BASIC statements:

```
sid = 54272
poke sid + 24,15: poke sid + 4,16
poke sid + 11,16: poke sid + 5,0: poke sid + 12,0
poke sid + 6,15*16: poke sid + 13,15*16: poke sid + 23,0
```

- 2) Next, select one row and one column value for each digit in the telephone number. The POKE statement for each row and column are:

```
Column 1: poke sid,117: poke sid + 1,77
Column 2: poke sid,152: poke sid + 1,85
Column 3: poke sid,161: poke sid + 1,94
Row 1: poke sid + 7,168: poke sid + 8,44
Row 2: poke sid + 7,85: poke sid + 8,49
Row 3: poke sid + 7,150: poke sid + 8,54
Row 4: poke sid + 7,74: poke sid + 8,60
```

For example, to generate a tone for the number 1, poke the values for row 1, column 1 as follows:

```
poke sid + 7,168: poke sid + 8,44: rem row 1
poke sid,117: poke sid + 1,77: rem column 1
```

- 3) Turn on the tones and add a time delay with these statements:

```
poke sid + 4,17: poke sid + 11,17: rem enable tones
for i = 1 to 50: next: rem time delay
```

- 4) Turn off the tones and add a time delay with the following statements:

```
poke sid + 4,16: poke sid + 11,16: rem dial tones
for i = 1 to 50: next: rem time delay
```

- 5) Now repeat steps 2 through 4 for each digit in the telephone number you are dialing.

- 6) Finally, disable the sound chip with this statement:

```
poke sid + 24,0
```

Note: The VIC 20 cannot simulate these tones with enough accuracy, so use rotary dialing with the VIC 20.

DETECTING TELEPHONE RINGING

To detect whether your telephone is ringing using a Commodore 128 or 64, use the following statement:

```
if(peek(56577) and 8) = 0 then print "ringing"
```

If location 56577 contains a value other than 0, the phone is not ringing.

To detect whether your telephone is ringing using a VIC 20, enter the following statement:

```
if (peek(37136) and 8) = 0 then print "ringing"
```

If location 37136 does not contain 0, the phone is not ringing.

PROGRAMMING THE TELEPHONE TO BE ON OR OFF THE HOOK

To program the phone to be off the hook using a Commodore 128 or 64, enter the following statements in a program:

```
oh = 56577:hi = 32:lo = 255-32  
poke(oh + 2),(peek(oh + 2)or hi)  
poke oh,(peek(oh) and lo)
```

To hang up the phone with a Commodore 128 or 64, enter these statements in a program:

```
poke oh,(peek(oh) or hi)
```

To program the phone to be off the hook using a VIC 20, use these statements in a program:

```
oh = 37136:hi = 32:lo = 255-32  
poke (oh + 2),(peek(oh + 2)or hi)  
poke oh,(peek(oh)and lo)
```

To hang up the phone with a VIC 20, enter this statement in a program:

```
poke oh,(peek(oh) and hi)
```

Here is the procedure to dial and originate a communication link:

- 1) Set the answer/originate switch to the "O" for originate

- 2) Program the telephone to be off hook.
- 3) Wait 2 seconds (for i = 1 to 500:next:rem 2 second delay)
- 4) Dial each digit and follow it with a delay (for i = 1 to 50:next)
- 5) When a carrier (high pitched tone) is detected, the Modem/300 automatically goes on-line with the computer you are connecting with.
- 6) Program the phone to hang up when you are finished.

Here is the procedure to answer a call:

- 1) Set the answer/originate switch to "A" for answer.
- 2) To manually answer, program the telephone to be OFF the hook.
- 3) To automatically answer, detect if the phone is ringing then program the phone to be OFF the hook.
- 4) The Modem/300 automatically answers the call.
- 5) Program the phone to hang up when you are finished.

DETECTING CARRIER

Your Commodore Modem/300 has been shipped from the factory with the ability to detect carrier on the Commodore 128, 64, SX-64 or VIC 20 computers.

This ability is useful in an unattended auto-answer mode. By monitoring the carrier detect line, the computer can be programmed to hang up after loss of carrier. This may not be foolproof however, since a caller may forget to hang up. You may want to monitor the transmit and receive data lines, and if there is no activity for five minutes or so, the program should have the modem hang up.

To detect carrier on the Commodore 128, 64, or SX-64, the following statements can be used in a BASIC program:

```
OH = 56577:
```

```
IF ((PEEK(OH) AND 16) = 16) THEN PRINT "NO CARRIER":
```

```
IF ((PEEK(OH) AND 16) = 0) THEN PRINT "CARRIER DETECTED"
```

To detect carrier on the VIC 20, the following statement can be used in a BASIC program:

```
OH = 37136:
```

```
IF((PEEK(OH) AND 16) = 16) THEN PRINT"NO CARRIER":
```

```
IF((PEEK(OH) AND 16) = 0) THEN PRINT"CARRIER DETECTED"
```

It is not possible to detect carrier on the Plus/4 computer. In fact, the Modem/300 will not work at all on the Plus/4 without modification. If you have a Plus/4 and would like to use the Modem/300, a solder jumper on the bottom of the modem near the edge connector must be opened. Be aware, however, that if you attempt this modification yourself, you will void your warranty. This modification should only be undertaken by qualified Commodore service personnel.

ROTARY (PULSE) DIALING

In order to dial a number with the Modem/300, the software in the computer must generate pulses at a prescribed rate. In the United States and Canada, the rate is between 8 and 10 pulses per second with a 58% to 64% break duty cycle. Most people, however, use 10 pulses per second, with a 60% break duty cycle.

To make a call, your software must first take the phone "off hook" (the equivalent of you picking up the receiver). Then to dial the first digit, a 3 for instance, the software must put the phone on hook for 60 milliseconds, and off-hook for 40 milliseconds. Repeat this process 3 times to dial a 3.

The same method is used to dial all other digits except 0, which is pulsed 10 times. Pause at least 600 milliseconds between each digit.

USING THE MODEM/300 WITH THE COMMODORE 128

The Modem/300 is used with the Commodore 128 in 64 mode the same way it is used with the Commodore 64. In 128 mode, BASIC

programs can generally run unmodified. Even PEEKs and POKEs to the user port and SID chip described for the Commodore 64 will work in 128 mode. Refer to the Commodore 128 Programmer's Reference Guide for information about machine language programs.

Federal Communications Commission (FCC) Statement

RADIO AND TELEVISION INTERFERENCE

This equipment generates and uses radio frequency energy and if not installed and use properly, in strict accordance with the manufacturer's instructions, may cause interference to radio and television reception. The modem has been tested and found to comply with the limits for a Class B computing device in accordance with the specifications in Subpart J of Part 15 of FCC rules, which are designed to provide reasonable protection against such interference in a residential installation.

There is no guarantee, however, that interference will not occur in a particular installation. If this device does cause interference to radio or television reception, which you can determine by monitoring reception when the modem is on and off, try to correct the problem with one or more of the following measures.

1. Reorient the receiving antenna.
2. Relocate the computer with respect to the receiver.
3. Relocate the computer and/or the receiver so that they are on separate branch circuits.

If necessary, consult your Commodore dealer or an experienced radio/television technician for additional suggestions. You may find the following booklet, prepared by the FCC, helpful:

How to Identify and Resolve Radio-TV INterference Problems
Stock No. 004-000-0345-4
U.S. Government Printing Office
Washington, DC 20402

NOTIFYING THE TELEPHONE COMPANY

Before you install your Modem/300, you should notify the telephone company that you plan to use a modem on your phone line. You will need to give the company the following information:

1. The telephone number (or numbers) to which the modem is to be connected.

2. The FCC registration number on the label supplied with the modem.
3. The ringer equivalence, also found on the modem label.

You should also inform the telephone company if you ever permanently remove the modem from your phone line.

The FCC has established rules which govern data modem direct connection to the telephone network. A jack is provided by the telephone company for the direct connection. Jacks of the modular type required for the connection are not provided on party lines or coin lines.

If the data modem is malfunctioning, it may be affecting the telephone lines outside the permissible operating specifications of FCC 68. In this case, the modem should be disconnected until the source of the difficulty is traced.

FOR CANADIAN MODEM USERS

The Canadian Department of Communications (DOC) label identifies certified equipment. This certification means that the equipment meets certain telecommunications network protective, operational and safety requirements. The department does not guarantee the equipment will operate to a user's satisfaction.

Before installing this equipment, make sure you are permitted to connect it to the facilities of the local telecommunications company. You must also install the equipment using an acceptable method of connection. In some cases you may also extend the company's inside wiring for single-line individual service by means of a certified connector assembly (telephone extension cord). You should be aware, however, that compliance with the above conditions may not prevent degradation of service in some situations.

Repairs to certified equipment should be made by an authorized Canadian maintenance facility designated by the supplier. Any repairs or alterations made by a user to this equipment, or equipment malfunctions, may give the telecommunications company cause to request the user to disconnect the equipment.

For your own protection, make sure the electrical ground connections of the power utility, telephone lines and internal metallic water

pipe system, if present, are connected together. This precaution may be particularly important in rural areas.

CAUTION: do not attempt to make such connections yourself; contact the appropriate electric inspection authority or electrician.

Commodore Modem/300 Load Number

The load number (LN) assigned to each terminal device denotes the percentage of the total load to be connected to the telephone loop used by the device, to prevent overloading. The termination on a loop may consist of any combination of devices, subject only to the requirement that the total of load numbers of all the devices not exceed 100. An alphabetic suffix is also specified in the load number for the appropriate ringing type (A or B), if applicable. For example LN = 5B designates a load number of 5 and a B-type ringer. The Canadian load number is found on the label on the bottom of the modem.

Glossary

Answer/Originate Mode—A mode of operation describing the sending or receiving of data from one computer to another. When your Modem/300 is set to originate mode, you dial the telephone call to the receiving computer. If your Modem/300 is set to answer mode, then you receive the call from the remote computer.

ASCII—The abbreviation for American Standard Code for Information Interchange. ASCII is the code that represents the characters on the keyboard. Standard ASCII uses 7 bits to represent a character, and Commodore ASCII uses all 8 bits (in a byte) to allow an extra 128 graphics characters. An ASCII conversion routine like Common Sense is necessary to communicate between a Commodore system and a standard ASCII device, such as many host computers or a non-Commodore printer.

Baud—a unit of measurement for the transmission of data; roughly translates into bits per second. The Modem/300 operates at 300 baud, that is it transmits 300 signal elements (bits) per second.

Bit—the smallest unit of information in a computer system. A bit may be either “off” representing zero, or “on” representing one. Specific combinations of bits represent meaningful information.

Block—A unit of information sent and received between devices, usually predefined in terms of number of bytes. For example, Commodore disk blocks (sectors) are 256 bytes; Xmodem blocks are 131 bytes.

Buffer—A temporary storage area, usually in a computer's memory. The data is stored in the buffer and later output to tape, disk, or printer or acted upon by the computer program currently in memory. Peripheral devices such as disk drives and printers can also have their own buffers to temporarily manage and store data.

Bulletin Board—An electronic public storage medium within an information network where messages can be transmitted and received.

Byte—a unit of information consisting of combinations of bits. A byte may represent a letter, number, special symbol, or control information.

Conferencing—A method of communication where several users within a large geographic area can “meet” in a public storage location within an information network and exchange messages, conduct computer dialogues or participate in a class.

Cursor—the indicator on your screen that shows where the next character will be displayed.

Database—An large collection of related information stored on a computer medium such as disk, tape or in a computer’s memory. Databases are often available to the public for a fee.

Download—The process of SAVEing information transmitted from another computer to your disk, tape or printer.

Dump—the bulk movement of information from one area (device) to another as a single activity.

Duplex—also called full-duplex—Indicates that transmission of data from remote to host and host to remote happens simultaneously. Opposite of half-duplex, where transmission is in only one direction at a time.

Escape codes—a special character used in telecommunications to indicate that the succeeding characters are different than the characters making up the actual message. The standard escape character is CHR\$(27), which usually signifies that the following characters will be control characters in an escape sequence that may include such directions as clear screen, position cursor, etc.

Files—collections of information on disk. Files may consist of programs, or text information for use by a program.

Handshake—the defined electrical line sequences for proper communication between digital devices.

Host/Remote Computer—In telecommunications the host is the computer that receives a call from the other computer. The host

controls the processing while the computer that originated the call, the remote, acts according to the way the host dictates.

Information Service—An electronic information source, usually on a large computer, such as CompuServe, that provides information to other computers through telecommunications. Information services may contain world and financial news, stock quotes, shop at home services, games and other public domain software.

Intelligent terminal—A remote computer with the capacity to upload (transmit) and download (SAVE) files to and from a host computer.

Line feed—In telecommunications, indicates that a carriage return will be added whenever the data being transmitted cannot fit on one line of the screen.

Modem—A communication device that acts as an interface (connector) between a computer and a telephone. It allows electronic signals from one computer to be sent across standard telephone lines to another computer. The word stands for MODulator/DEMulator.

On-line—The state of being connected to a host computer as a terminal.

Parity—The agreed-upon definition of valid bit combinations in a character. The parity bit is used as a checking mechanism to determine if transmission has been complete. Parity may be even, odd, mark, or space.

Program File—A set of computer instructions stored on disk or tape, which can be executed in a computer's memory.

Protocol—The appropriate settings or parameters required for accurate and correct sending and receiving of information during a telecommunications dialogue. The telecommunication protocol includes parameters such as duplex, parity, word length and baud.

Sequential File—A collection of related data stored (one character after the other) as a complete unit on disk or tape.

Stop Bit—A bit that signals the end of a character being transmitted.

Synchronous/Asynchronous Communication—A synchronous computer system transmits data according to and in unison with

the internal system clock of the computer. Asynchronous systems, like your Commodore computer, transmit data independently of the internal system clock and use start and stop bits to regulate data transmission.

Telecommunications—the sending and receiving of information between computers across standard telephone wires. Also known as telecomputing.

Terminal Mode—The mode of operation in which sending and receiving information takes place.

Upload—The process of transmitting the contents of your computer's memory to the memory of another computer where it can be executed or SAVED.

Word length—The number of data bits in a telecommunications word, or unit of data transmission. Usually 7 or 8 (plus start bit, stop bit(s), and optional parity bit.). Most programs default to one start bit, eight data bits, one stop bit and no parity.

NOTES . . .

COMMODORE 

Commodore Business Machines, Inc.
1200 Wilson Drive • West Chester, PA

Commodore Business Machines Limited
3470 Pharmacy Avenue • Agincourt, Ontario, M1W 3G3